

Over 100 New Products

OVER ONE MILLION STOCK ITEMS

 **SAMPLING
SYSTEMS**

www.sampling.com

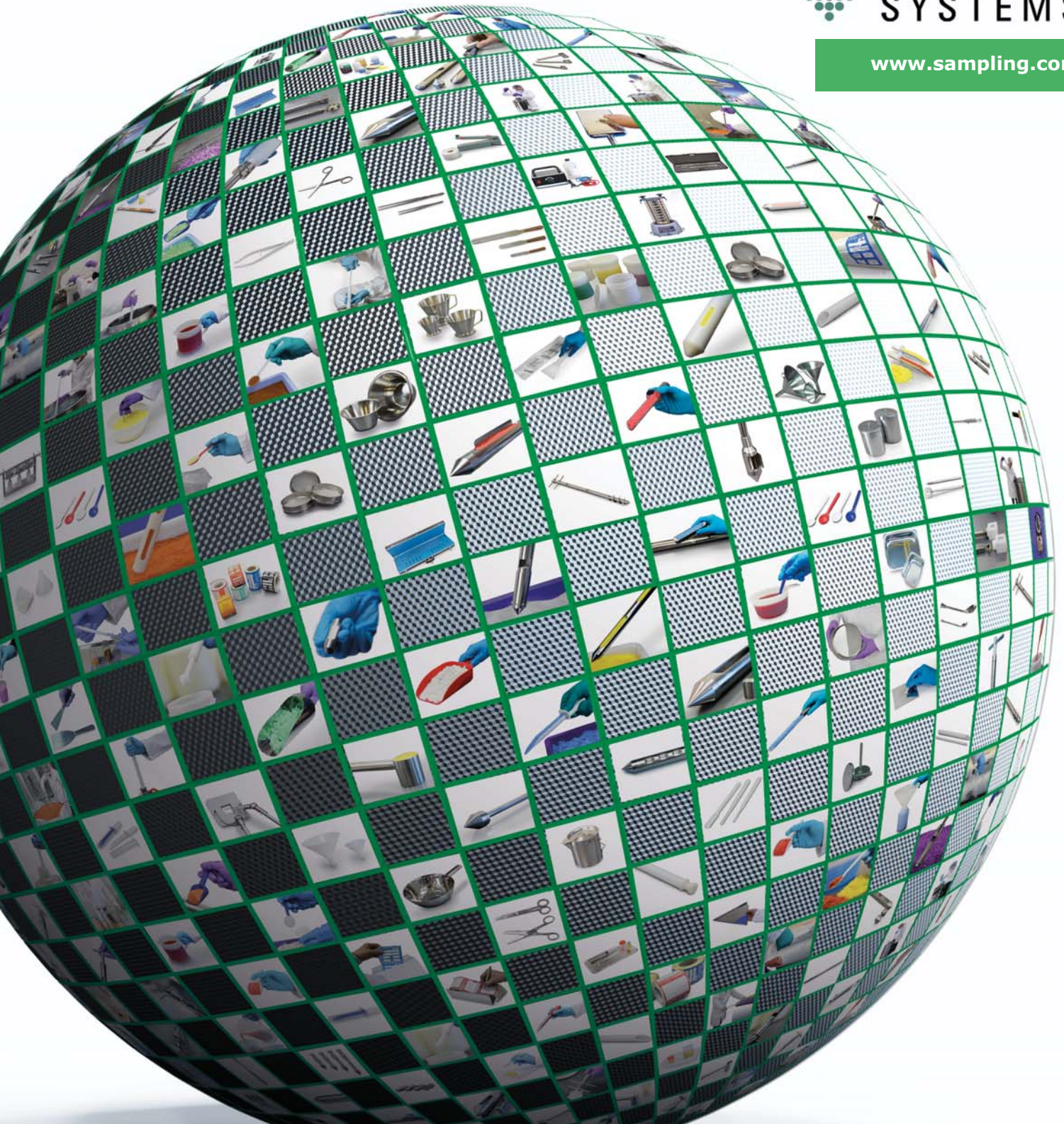

World Class Equipment
worldwide



Welcome to the latest edition of our Range Brochure

Welcome to the latest edition of the Sampling Systems Range Brochure.

The feedback and comments of our customers have enabled us to continue to add new products and equipment to our range, which we believe to be our most comprehensive to date.

Over 100 new products have been added to our catalogue. These include a new range of disposable spoons, long handled scoops, stainless steel containers and granule samplers.

We continue to place great emphasis on the development of innovative and advanced devices. Therefore, we are proud to introduce the brand new AccuPod Sampler; the first in a new generation of hybrid samplers. Further details can be found on pages 74-75.

Our range is consistently developing and expanding, and we are also able to manufacture custom items on request.

Next day delivery is offered for 95% of our expansive product catalogue, with over one million items currently in stock. We assure the highest standards of quality, with full material certification available upon request.

Contact a member of our team if you require more information. We look forward to hearing from you.

Jonathan Fenner

Simon Fenner

From Design



To Manufacture

From the initial design to the final stages of manufacturing, we immerse ourselves in the entire process of developing our products. This ensures that our high standards of quality and efficiency are maintained, while allowing us complete control over every detail from prototype to the final delivery.

Implementing the latest design techniques and cutting edge manufacturing technology, we offer a diverse and comprehensive range of sampling equipment, available to order from stock.

What's **New**
Over 100 New
Products

New Sizes

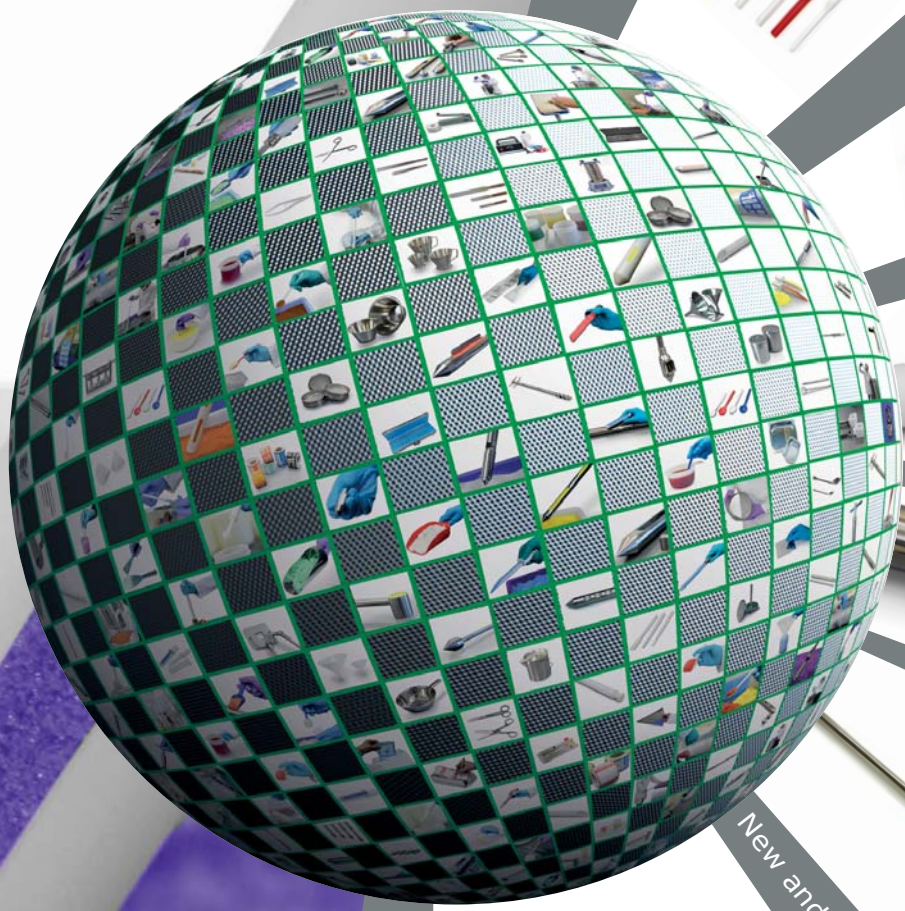

New and Improved SteriWare Packaging

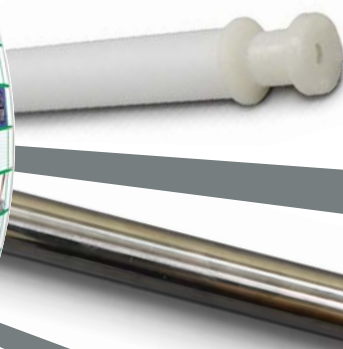
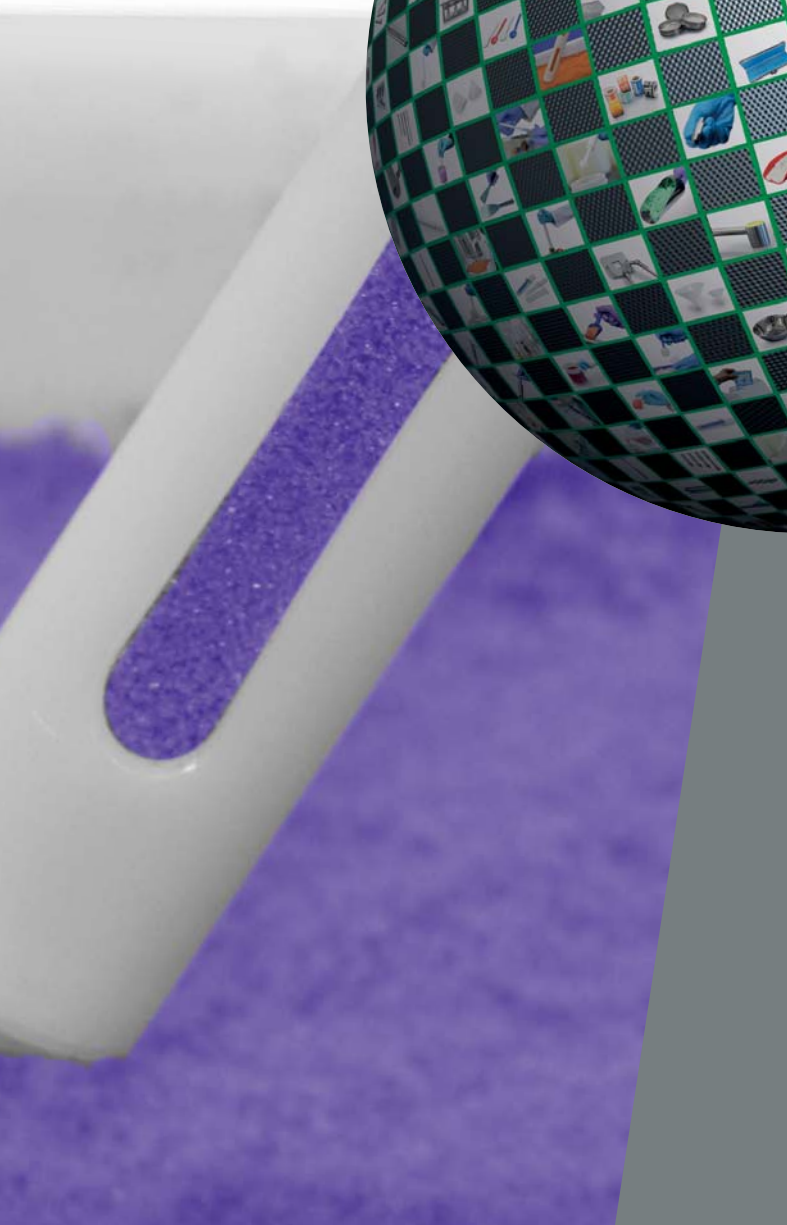

The New V-Spatula

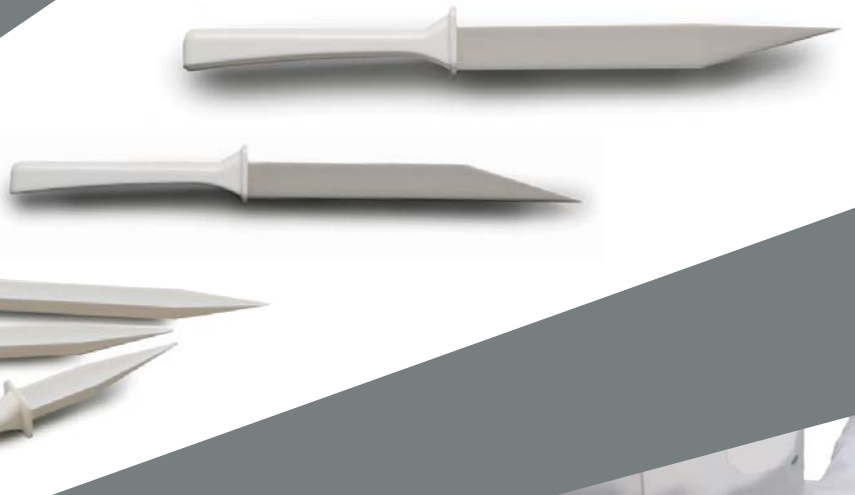

All New Disposable Samplers



New Reusable Samplers

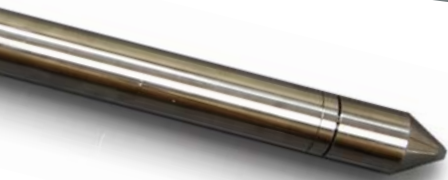

New Container and Drum Range



contents

Disposables

Pages 7 to 52



Powder Samplers

Pages 53 to 88



Liquid Samplers

Pages 89 to 114



Semi Solid Samplers

Pages 115 to 122



Environmental Sampling

Pages 123 to 133



Bottles & Containers

Pages 134 to 152



Accessories

Pages 153 to 188



Labels

Pages 189 to 195



Disposables

Quality Guaranteed



The SteriWare Difference*

Disposables

<p>Cleanroom Manufacture</p>	<p>100% Inspection</p>	<p>Individually Bagged</p>
<p>Full Documentation & Traceability</p>	<p>Over one million stock items</p>	<p>Fast delivery worldwide</p>
<p>Ultra Strong Packaging with Easy Opening</p>	<p>Sterility Assurance</p>	<p>Specials and New Designs</p>

* Please see the specifications sheets for confirmation



SteriWare® Long Handled Scoop

Keep hands out of the product

SteriWare Long Handled Scoops are the ideal tool for reaching into deep containers. The extra long handle will help operators keep their hands out of the product.

The other advantage of a long handle is that it makes the scoop more visible if it is left in the powder.

Both non-sterile and sterile scoops are available from stock. They are manufactured in a cleanroom to ensure cleanliness and reduce particulate contamination.

- Moulded & Packed in a Cleanroom
- Individually Bagged
- Made from FDA, EC 1935/2004 & EU 10/2011 conforming HDPE
- BSE/TSE Free
- Available in uncoloured natural HDPE or bright red HDPE
- Full Batch Traceability
- Available sterile (SAL 10⁻⁶) and non-sterile

The handle length is 300mm. Our range of single use scoops are ideal for use in the laboratory, production and warehouse.



Part No.	Sterile	Nominal Scoop Volume	Overall Length	Overall Width	Colour	Material	Quantity per Box
8341H-100	No	100ml	400mm	50mm	Natural	HDPE	50
8341H-100S	Yes	100ml	400mm	50mm	Natural	HDPE	50
8341R-100	No	100ml	400mm	50mm	Red	HDPE	50
8341R-100S	Yes	100ml	400mm	50mm	Red	HDPE	50

Class Leading documentation



Certificates of Conformity and Specification sheets can be downloaded from: www.sampling.com

SteriWare PharmaScoop®

The Industry Standard - High Quality, Single Use Powder Scoops

The Sampling Systems range of disposable PharmaScoops® have been specially designed for dispensaries and manufacturing. They are the ultimate in quality and affordability.

SteriWare® PharmaScoops® are used by pharmaceutical, food and industrial companies all over the world.

- Moulded & Packed in a Cleanroom.
- Individually Bagged in ultra strong packing with easy opening design
- Made from FDA, EC 1935/2004 & EU 10/2011 Conforming Materials
- BSE/TSE Free
- Full Batch Traceability
- Available sterile (SAL 10⁻⁶) and non-sterile from stock



Don't forget your scoop!
A brightly coloured scoop can be easily seen.



Cleanroom

All scoops are manufactured, inspected and packed in a cleanroom.

The GMP PharmaScoop

It is Good Manufacturing Practice to keep your hands out of the product as much as possible. In accordance with this we have positioned the ergonomic handles high up on the scoop.

**GMP
Correct**

Use straight from the bag



White



PS - Best Seller



Part No.	Nominal Capacity	Sterile	Colour	Material	Quantity per Box
8045A-30	30ml	No	White	PS	100
8045A-30S	30ml	Yes	White	PS	100
8045A-60	60ml	No	White	PS	100
8045A-60S	60ml	Yes	White	PS	100
8045A-125	125ml	No	White	PS	100
8045A-125S	125ml	Yes	White	PS	100
8045A-250	250ml	No	White	PS	85
8045A-250S	250ml	Yes	White	PS	100
8045A-500	500ml	No	White	PS	100
8045A-500S	500ml	Yes	White	PS	100
8045A-1000	1000ml	No	White	PS	100
8045A-1000S	1000ml	Yes	White	PS	100
8045A-2500	2500ml	No	White	PS	60
8045A-2500S	2500ml	Yes	White	PS	60



PP and HDPE - For Extra Chemical Resistance



Part No.	Nominal Capacity	Sterile	Colour	Material	Quantity per Box
8045P-30	30ml	No	White	PP	100
8045P-30S	30ml	Yes	White	PP	100
8045P-60	60ml	No	White	PP	100
8045P-60S	60ml	Yes	White	PP	100
8045P-125	125ml	No	White	PP	100
8045P-125S	125ml	Yes	White	PP	100
8045P-250	250ml	No	White	PP	100
8045P-250S	250ml	Yes	White	PP	100
8045P-500	500ml	No	White	PP	100
8045P-500S	500ml	Yes	White	PP	100
8045P-1000	1000ml	No	White	PP	100
8045P-1000S	1000ml	Yes	White	PP	100
8045P-2500	2500ml	No	White	PP	60
8045P-2500S	2500ml	Yes	White	PP	60
8045H-30	30ml	No	White	HDPE	100
8045H-60	60ml	No	White	HDPE	100
8045H-60S	60ml	Yes	White	HDPE	100
8045H-125	125ml	No	White	HDPE	100
8045H-125S	125ml	Yes	White	HDPE	100
8045H-250	250ML	No	White	HDPE	100
8045H-250S	260ml	Yes	White	HDPE	100
8045H-500	500ml	No	White	HDPE	100
8045H-500S	500ml	Yes	White	HDPE	100
8045H-1000	1000ml	No	White	HDPE	100
8045H-1000S	1000ml	Yes	White	HDPE	100

SteriWare RED PharmaScoop®

Highly Visible, High Quality, Single Use Powder Scoops

New sizes

Red PharmaScoops offer all the features of our classic white PharmaScoops but they are a highly visible red colour. We use a special food grade red dye to colour the scoops.

Brightly coloured scoops are especially visible if they are left in light coloured powders.

- Top seller
- Moulded & packed in a class 100,000 Cleanroom
- Each scoop is individually wrapped in ultra strong packing that is easy to open
- Made from FDA, EC 1935/2004 & EU 10/2011 conforming polystyrene (PS)
- BSE/TSE free
- Available sterile (SAL 10⁻⁶) and non-sterile



Unique Benefit



Red

Cleanroom Manufacture

All our scoops are manufactured and packed in a cleanroom



Part No.	Nominal Capacity	Sterile	Colour	Material	Quantity per Box
8045R-30	30ml	No	Red	PS	100
8045R-30S	30ml	Yes	Red	PS	100
8045R-60	60ml	No	Red	PS	100
8045R-60S	60ml	Yes	Red	PS	100
8045R-125	125ml	No	Red	PS	100
8045R-125S	125ml	Yes	Red	PS	100
8045R-250	250ml	No	Red	PS	100
8045R-250S	250ml	Yes	Red	PS	100
8045R-500	500ml	Yes	Red	PS	100
8045R-500S	500ml	Yes	Red	PS	100
8045R-1000	1000ml	No	Red	PS	100
8045R-1000S	1000ml	Yes	Red	PS	100
8045R-2500	2500ml	No	Red	PS	60
8045R-2500S	2500ml	Yes	Red	PS	60

SteriWare BLUE FoodScoop®

Bright, High Quality, Single Use Powder Scoops

Highly visible blue Scoops are a firm favourite with food and pharmaceutical companies. The scoops have a special food grade blue dye to them their distinctive, highly visible blue colour. This means they can be easily seen should they be left in the powder (in line with HACCP guidelines).

- Moulded & packed in a class 100,000 Cleanroom
- Each scoop is individually wrapped in our ultra strong packing that is designed to be easily opened
- Made from FDA, EC 1935/2004 & EU 10/2011 conforming Polypropylene (PP)
- BSE/TSE free
- Large stocks for fast delivery worldwide
- Available sterile (SAL 10⁻⁶) and non-sterile



Blue



Disposables



Part No.	Nominal Capacity	Sterile	Colour	Material	Quantity per Box
8045B-60	60ml	No	Blue	PP	100
8045B-60S	60ml	Yes	Blue	PP	100
8045B-125	125ml	No	Blue	PP	100
8045B-125S	125ml	Yes	Blue	PP	100
8045B-250	250ml	No	Blue	PP	100
8045B-250S	250ml	Yes	Blue	PP	100
8045B-500	500ml	No	Blue	PP	100
8045B-500S	500ml	Yes	Blue	PP	100
8045B-1000	1000ml	No	Blue	PP	100
8045B-1000S	1000ml	Yes	Blue	PP	100
8045B-2500	2500ml	No	Blue	PP	60
8045B-2500S	2500ml	Yes	Blue	PP	60

SteriWare® Counting Triangle

High quality, single use tablet counting tray



The SteriWare Counting Triangle is ideal for counting round tablets. They are manufactured and packed in a cleanroom and so can be used straight from the bag.

- Suitable for left handed and right handed operators
- Individually bagged
- Made from FDA, EC 1935/2004 & EU 10/2011 conforming PS
- Cleanroom manufacture and packing (ensures cleanliness)
- Available from stock for fast delivery worldwide



SteriWare®



Part No.	Side length	Height	Sterile	Material	Quantity per Box
8066A-1	235mm	15mm	No	PS	30
8066A-1S	235mm	15mm	Yes	PS	30

Disposables

SteriWare Capsule Counting Trays

Use straight from the bag



The disposable counting trays are made from robust, shatterproof PS. They are suitable for use with all capsules from Size 2 to Size 00.

- Individually bagged
- FDA and EU 10/2011 conforming material
- Cleanroom manufacture and packing (ensures cleanliness)
- Available from stock for fast delivery worldwide
- Available sterile (SAL 10⁻⁶) and non-sterile



SteriWare®



Part No.	Length	Width	Sterile	Material	Quantity per Box
8444A-1	260mm	130mm	No	PS	20
8444A-1S	260mm	130mm	Yes	PS	20

SteriWare® Long Handled Spoon

With an ergonomic angled handle



SteriWare Long Handled Spoons are ideal for reaching into large containers or difficult to reach places.

Each spoon has a robust 300mm handle. The bowl is available either with a straight or an offset profile. The offset version aids pouring (for right handed people).

- Moulded & Packed in a Cleanroom
- Individually Bagged
- Made from FDA, EC 1935/2004 & EU 10/2011 conforming materials
- BSE/TSE Free
- Full Batch Traceability
- Available Sterile (gamma irradiated)
- Made from chemically resistant HDPE
- Available sterile (SAL 10⁻⁶) and non-sterile



Disposables

Straight Spoon



Part No.	Nominal Spoon Volume	Sterile	Handle Length	Material	Quantity per Box
8209H-10	10ml	No	300mm	HDPE	100
8209H-10S	10ml	Yes	300mm	HDPE	100
8209H-20	20ml	No	300mm	HDPE	100
8209H-20S	20ml	Yes	300mm	HDPE	100

Offset Spoon



Part No.	Nominal Spoon Volume	Sterile	Handle Length	Material	Quantity per Box
8293H-10	10ml	No	300mm	HDPE	100
8293H-10S	10ml	Yes	300mm	HDPE	100
8293H-20	20ml	No	300mm	HDPE	100
8293H-20S	20ml	Yes	300mm	HDPE	100



SteriWare® Sample Spoons

Ideal for dispensing and sampling small quantities

Our range of low cost single use spoons allow quick and efficient surface sampling of powders and granules. Alternatively they can be also used for dispensing small quantities.

- Moulded & Packed in a Cleanroom
- Individually Bagged
- Made from FDA, EC 1935/2004 & EU 10/2011 conforming polystyrene (PS)
- BSE/TSE Free
- Full Batch Traceability
- Available sterile (SAL 10⁻⁶) and non-sterile



Part No.	Nominal Spoon Volume	Colour	Sterile	Overall Length	Material	Quantity per Box
8088A-03	3ml	White	No	173mm	PS	100
8088A-03S	3ml	White	Yes	173mm	PS	100
8088A-10	10ml	White	No	185mm	PS	100
8088A-10S	10ml	White	Yes	185mm	PS	100
8088R-10S	10ml	Red	Yes	185mm	PS	100



SteriWare® FoodSpoon

Highly Visible Sampling Spoon

The blue FoodSpoon from Sampling Systems is ideal for sampling small amounts of powder and for dispensing small quantities.

Blue FoodSpoons are manufactured from food grade polypropylene. Their bright blue colour ensures that they are highly visible and easy to spot if left in most powders or granules (in line with HACCP guidelines).

Each spoon is individually bagged and can be used straight from the bag.

- Moulded & Packed in a Cleanroom
- Individually Bagged
- Made from FDA, EC 1935/2004 & EU 10/2011 conforming Polypropylene (PP)
- BSE/TSE Free
- Full Batch Traceability
- Available sterile (SAL 10⁻⁶) and non-sterile



Part No.	Nominal Spoon Volume	Colour	Sterile	Overall Length	Material	Quantity per Box
8088B-10	10ml	Blue	No	185mm	PP	100
8088B-10S	10ml	Blue	Yes	185mm	PP	100

Disposable FoodSpoons are also available in other materials on request. Please contact us for details.

Mini Spoon 2.5/5ml

Ideal for Powders and Liquids

New

Our Mini Spoons (dosing) are high quality, cost effective spoons that are ideal for sampling and measuring small quantities. The spoons have a 2.5ml bowl at one end and a 5ml bowl at the other. Dosing Spoons are ideal for healthcare, laboratory and quality control use.

The range is moulded and individually packed in a cleanroom to ensure full cleanliness. We carry large stocks so they can be delivered anywhere in the world fast.

- Manufactured from robust shatter-proof PS.
- EC and FDA conforming material
- BSE/TSE free
- Fast delivery worldwide
- Packing is in our easy open but robust bags. The bags are FDA and EC compliant material
- Available sterile (SAL 10⁻⁶) and non-sterile
- Special colours and packing are available on request (subject to minimum quantities)



Disposables



Part No.	Volume	Sterile	Material	Quantity per Box
8642A-01	2.5ml and 5ml	No	PS	130
8642A-01S	2.5ml and 5ml	Yes	PS	130



SteriWare® Volumetric Spoons

Single use, accurate measuring spoons



Volumetric Spoons allow small volumes to be accurately measured. The Volumetric Spoons are designed to be used straight from the bag.

- Moulded & Packed in a Cleanroom
- Individually Bagged
- Made from FDA, EC 1935/2004 & EU 10/2011 conforming HDPE
- BSE/TSE Free
- Full Batch Traceability
- Available sterile (SAL 10⁻⁶) and non-sterile

NB. Volumetric spoons are not certified measuring devices. User validation is required. If in doubt please contact us



Part No.	Flat Fill Volume	Bowl Diameter	Overall Length	Sterile	Material	Quantity per Box
8640H-01	1ml	18mm	153mm	No	HDPE	100
8640H-01S	1ml	18mm	153mm	Yes	HDPE	100
8640H-0123S	1.23ml	18mm	155mm	Yes	HDPE	100
8640H-0246S	2.46ml	23mm	160mm	Yes	HDPE	100
8640H-05	5ml	29mm	165mm	No	HDPE	100
8640H-05S	5ml	29mm	165mm	Yes	HDPE	100
8640H-10	10ml	35mm	171mm	No	HDPE	100
8640H-10S	10ml	35mm	171mm	Yes	HDPE	100
8640H-20	20ml	43mm	180mm	No	HDPE	100
8640H-20S	20ml	43mm	180mm	Yes	HDPE	100



SteriWare® Well Packed

All our SteriWare products are packed into high quality boxes for safe storage and transportation.

It is our priority that your SteriWare products will arrive quickly, safely and in good condition.

See the difference with SteriWare.

Disposables



SteriWare® Flat-Spatula

Ideal for stirring, product manipulation and powder handling



The disposable Flat-Spatula is perfectly designed for a multitude of functions including stirring liquids, manipulation and powder sampling.

- Moulded & Packed in a Cleanroom
- Individually Bagged
- Made from FDA, EC 1935/2004 & EU 10/2011 conforming materials
- BSE/TSE Free
- Full Batch Traceability
- Available sterile (SAL 10⁻⁶) and non-sterile



Part No.	Sterile	Colour	Material	Blade Width x Length	Overall Length	Quantity per Box
8729A-170	No	White	PS	13 x 40mm	170mm	100
8729A-170S	Yes	White	PS	13 x 40mm	170mm	100

Disposables



Why use a disposable SteriWare® device?

Quality

- Cross-contamination risk is eliminated - the device can be used straight from the bag
- No cleaning is required before or after sampling
- No cleaning validation (this is very expensive to set up and run)
- Most devices are manufactured in a Cleanroom environment (check individual sampler descriptions and specifications)
- Suitable for all industries (pharmaceutical, food, chemical, cosmetic, biotechnology etc.)

Financial

- Save time and money (it will cost more to clean a reusable sampler than to buy a disposable sampler)

Speed

- SteriWare products can be used straight from the bag



SteriWare® Micro-Spatulas

Ideal for handling small quantities of powders & granules



The disposable Micro-Spatula is ideal for sampling small volumes. Its narrow sampling blade enables samples to be taken from very small containers such as vials.

- Moulded & Packed in a Cleanroom
- Available in 3 colours
- Individually Bagged
- Made from FDA, EC 1935/2004 & EU 10/2011 conforming materials
- BSE/TSE Free
- Full Batch Traceability
- Available sterile (SAL 10⁻⁶) and non-sterile
- Different blade widths available from stock. Ideal for small vial or sample containers
- Also available in HDPE for extra chemical resistance



Disposables



Part No.	Nominal Sample Volume	Sterile	Colour	Material	Blade Width x Length	Overall Length	Quantity per Box
8015V-170	0.3ml	No	White	PS	4 x 40mm	170mm	100
8015V-170S	0.3ml	Yes	White	PS	4 x 40mm	170mm	100
8015N-170	0.5ml	No	White	PS	6 x 40mm	170mm	100
8015N-170S	0.5ml	Yes	White	PS	6 x 40mm	170mm	100
8015A-170	2ml	No	White	PS	13 x 40mm	170mm	100
8015A-170S	2ml	Yes	White	PS	13 x 40mm	170mm	100
8015H-170	2ml	No	White	HDPE	13 x 40mm	170mm	100
8015H-170S	2ml	Yes	White	HDPE	13 x 40mm	170mm	100
8015VR-170S	0.3ml	Yes	Red	PS	4 x 40mm	170mm	100
8015NR-170S	0.5ml	Yes	Red	PS	6 x 40mm	170mm	100
8015R-170S	2ml	Yes	Red	PS	13 x 40mm	170mm	100
8015VB-170S	0.3ml	Yes	Blue	PP	4 x 40mm	170mm	100
8015NB-170S	0.5ml	Yes	Blue	PP	6 x 40mm	170mm	100
8015B-170S	2ml	Yes	Blue	PP	13 x 40mm	170mm	100



SteriWare® Powder Bottle

Individually Bagged Bottles Made in a Cleanroom



SteriWare Powder Bottles are a new premium screw top bottle from Sampling Systems. They are designed to meet the requirements of the pharmaceutical and hygienic industries.

Powder Bottles are moulded and packed in a Class 100,000 cleanroom. The bottles have a wide opening and so are ideal when working with powders.



- Powder tight
- Available in 250ml and 500ml sizes
- Other sizes to follow
- Manufactured & Packed in a Cleanroom
- Individually Bagged
- Made from FDA, EC 1935/2004 & EU 10/2011 conforming PP
- BSE/TSE Free
- Full Batch Traceability
- Available sterile (SAL 10⁻⁶) and non-sterile



Disposables



Part No.	Nominal Volume	Sterile	Overall Height	Outer Diameter	Material	Quantity per Box
8890P-250	250ml	No	88mm	76mm	PP	50
8890P-250S	250ml	Yes	88mm	76mm	PP	50
8890P-500	500ml	No	106mm	94mm	PP	37
8890P-500S	500ml	Yes	106mm	94mm	PP	37



Sterile Liquid & Powder Bottle

Individually Bagged Bottles - 1 Litre

The perfect bottle for use in laboratory and production. Its wide mouth means it is easy to handle both powders and liquids.

It comes supplied in a robust laminate bag. After packing it is sterilised using gamma irradiation. Simply unwrap and use.

- Powder and water tight
- Packed in a Cleanroom
- Individually Bagged
- Made from FDA, EC 1935/2004 & EU 10/2011 conforming HDPE/PP
- BSE/TSE Free
- Handy 1 litre size



Part No.	Nominal Volume	Sterile	Overall Height	Outer Diameter	Material	Quantity per Box
8404H-1000S	1000ml	Yes	88mm	76mm	HDPE Body & PP lid	30

Sample Kit

Containing sterile Scoop and a sterile Sample Bag

The Sample Kit contains everything you need to take powder samples. Everything in the kit has been sterilised by gamma irradiation to help ensure the quality of your samples.

The kit comprises of 10 sets. Each set is individually bagged and contains a sterile Scoop (30ml) and a sterile Sample Bag (900ml).

The 30ml Scoop is made and packed in a Class 100,000 cleanroom and is made from FDA & EU acceptable polystyrene.

The sterile Sample Bags have a large writing area for recording the details of the sampling activity.

Each kit contains:

- 10 x sterile Scoop 30ml
- 10 x sterile Sample Bag 900ml



Operation

1. Open outer bag and remove Scoop and Sample Bag
2. Write sample details on the Sample Bag
3. Use Scoop to take sample
4. Place Scoop and sample inside the Sample Bag
5. Seal the Sample Bag



Part No.	Nominal Scoop Volume	Scoop Material	Sample Bag Material	Quantity per Box
8480A-30S	30ml	PS (sterile)	LDPE (sterile)	10 scoops & 10 Sample Bags

SteriWare® Bowls

Ideal for handling and mixing Powders and Liquids

The Disposable Bowl is ideal for pre-mixing potent drugs and highly coloured substances prior to blending.

- Moulded & Packed in a Cleanroom
- Individually Bagged
- Made from FDA, EC 1935/2004 & EU 10/2011 conforming HDPE
- BSE/TSE Free
- Full Batch Traceability
- Available sterile (SAL 10⁻⁶) and non-sterile



SteriWare®



Part No.	Nominal Volume	Sterile	Diameter	Height	Material of Construction	Quantity per Box
8017H-05	500ml	No	129mm	70mm	HDPE	100
8017H-05S	500ml	Yes	129mm	70mm	HDPE	100

SteriWare® Mixing Bowl

Large volume bowl made in a Cleanroom

The 3 litre mixing bowl from Sampling Systems is ideal for laboratories, production and small scale work.

- Individually wrapped
- Sterilised by irradiation
- Made from FDA, EC 1935/2004 & EU 10/2011 conforming HDPE
- Robust construction
- Call us for a free sample
- BSE/TSE free
- Available sterile (SAL 10⁻⁶) and non-sterile



Part No.	Nominal Volume	Sterile	Diameter	Height	Material of Construction	Quantity per Box
8017H-30	3000ml	No	256mm	109mm	HDPE	15
8017H-30S	3000ml	Yes	256mm	109mm	HDPE	15

SteriWare® Jugs (Graduated)

Cleanroom manufactured

Our range of high quality jugs are designed to be used straight from the bag, no cleaning is required. The specially designed ergonomic handle is rounded to make it comfortable to hold and use.

These measuring beakers with handles are also graduated.

- Moulded and packed in a cleanroom
- Individually Bagged
- Graduation marks
- Made from FDA, EC 1935/2004 & EU 10/2011 conforming PP
- BSE/TSE Free
- Full Batch Traceability
- Available Sterile (gamma irradiated)



Part No.	Nominal Volume	Sterile	Diameter	Height	Material	Quantity per Box
8432P-500	500ml	No	90mm	130mm	PP	35
8432P-500S	500ml	Yes	90mm	130mm	PP	35
8432P-1000	1000ml	No	120mm	170mm	PP	18
8432P-1000S	1000ml	Yes	120mm	170mm	PP	18

Disposables

SteriWare® Jugs

Sturdy jugs with an extra wide base

These disposable Jugs have a wide base which makes them very stable. The handle is rounded to make it comfortable to hold.

These jugs are non-graduated.

- Moulded and packed in a Cleanroom
- Individually Bagged
- Made from FDA, EC 1935/2004 & EU 10/2011 conforming HDPE
- BSE/TSE Free
- Full Batch Traceability
- Available sterile (SAL 10⁻⁶) and non-sterile



Part No.	Nominal Volume	Sterile	Diameter	Height	Material	Quantity per Box
8049H-2000	2000ml	No	129mm	152mm	HDPE	20
8049H-2000S	2000ml	Yes	129mm	152mm	HDPE	16

SteriWare® Pallet Knife

- Moulded & Packed in a Cleanroom
- Individually Bagged
- Made from FDA, EC 1935/2004 & EU 10/2011 conforming HDPE
- BSE/TSE Free
- Full Batch Traceability
- Available sterile (SAL 10⁻⁶) and non-sterile



Part No.	Blade Length	Blade Width	Overall Length	Sterile	Material	Quantity per Box
8175H-150	150mm	40mm	260mm	No	HDPE	100
8175H-150S	150mm	40mm	260mm	Yes	HDPE	100
8175H-200	200mm	45mm	300mm	No	HDPE	100
8175H-200S	200mm	45mm	300mm	Yes	HDPE	100

SteriWare® Scraper

The SteriWare scraper is ideal for use with foodstuffs, cosmetics and pharmaceuticals. The ergonomic design means they are easy to use. Ideal for scraping, cleaning and a many other uses.

- Moulded & Packed in a Cleanroom
- Individually Bagged
- Made from FDA, EC 1935/2004 & EU 10/2011 conforming HDPE
- BSE/TSE Free
- Full Batch Traceability
- Available sterile (SAL 10⁻⁶) and non-sterile



Part No.	Blade Length	Blade Width	Overall Length	Sterile	Material	Quantity per Box
8785H-75	75mm	75mm	190mm	No	HDPE	100
8785H-75S	75mm	75mm	190mm	Yes	HDPE	100
8785H-110	110mm	110mm	225mm	No	HDPE	100
8785H-110S	110mm	110mm	225mm	Yes	HDPE	100

SteriWare® Blue Scraper

- Moulded & Packed in a Cleanroom
- Individually Bagged
- Made from FDA, EC 1935/2004 & EU 10/2011 conforming PP
- BSE/TSE Free
- Full Batch Traceability
- Available sterile (SAL 10⁻⁶) and non-sterile



Part No.	Blade Length	Blade Width	Overall Length	Sterile	Material	Quantity per Box
8785B-75	75mm	75mm	190mm	No	Blue PP	100
8785B-75S	75mm	75mm	190mm	Yes	Blue PP	100

Disposable Tray

High quality tray made in a Cleanroom

The disposable Tray is ideal for hygienic applications within hospitals and pharmaceutical factories.

- Moulded & Packed in a Cleanroom
- Individually Bagged
- Made from FDA, EC 1935/2004 & EU 10/2011 conforming PP
- BSE/TSE Free
- Full Batch Traceability
- Available sterile (SAL 10⁻⁶) and non-sterile



Part No.	Dimensions (L x W x H)	Nominal Volume	Sterile	Material	Quantity per Box
8081P-3000	310 x 265 x 55mm	3000ml	No	PP	30
8081P-3000S	310 x 265 x 55mm	3000ml	Yes	PP	30

SteriWare® Knife

Hygienic Knife, made in a cleanroom

The disposable Knife can be used for preparing samples as well as general laboratory use.

Each knife is moulded and packed in a Cleanroom and can be used straight from the bag.

- Moulded & Packed in a Cleanroom
- Made from FDA, EC 1935/2004 & EU 10/2011 conforming HDPE
- BSE/TSE Free
- Full Batch Traceability
- Available sterile (SAL 10⁻⁶) and non-sterile



Part No.	Individually Bagged	Sterile	Overall Length	Blade Length	Material	Quantity per Box
8039A-100	No	No	160mm	60mm	HDPE	100
8039H-100	Yes	No	160mm	60mm	HDPE	100
8039H-100S	Yes	Yes	160mm	60mm	HDPE	100

SteriWare® Liquid Funnel

- Moulded & Packed in a Cleanroom
- Individually Bagged
- Made from FDA, EC 1935/2004 & EU 10/2011 conforming HDPE
- BSE/TSE Free
- Full Batch Traceability
- Available sterile (SAL 10⁻⁶) and non-sterile
- Small hygienic side handle



Part No.	Top Diameter	Spout Diameter	Overall Height	Sterile	Material	Quantity per Box
8370H-50	50mm	7mm	58mm	No	HDPE	TBC
8370H-50S	50mm	7mm	58mm	Yes	HDPE	TBC
8370H-100	100mm	10mm	125mm	No	HDPE	50
8370H-100S	100mm	10mm	125mm	Yes	HDPE	50
8370H-200	200mm	14mm	180mm	No	HDPE	20
8370H-200S	200mm	14mm	180mm	Yes	HDPE	10

New sizes

Disposables

SteriWare® Blue Liquid Funnel

- Moulded & Packed in a Cleanroom
- Individually Bagged
- Made from FDA, EC 1935/2004 & EU 10/2011 conforming PP
- BSE/TSE Free
- Full Batch Traceability
- Available sterile (SAL 10⁻⁶) and non-sterile



Part No.	Top Diameter	Spout Diameter	Overall Height	Sterile	Material	Quantity per Box
8370B-100	100mm	12mm	125mm	No	Blue PP	50
8370B-100S	100mm	12mm	125mm	Yes	Blue PP	50



SteriWare® Powder Funnel

Wide mouth so powder flows easily

The disposable Powder Funnel is ideal for transferring powders. Available both sterile and non-sterile. Made from chemically resistant food grade HDPE.

- Individually bagged
- Made from FDA, EC 1935/2004 & EU 10/2011 conforming polymer
- Cleanroom manufacture and packing (ensures cleanliness)*
- Available from stock for fast delivery worldwide
- Available sterile (SAL 10⁻⁶) and non-sterile



Part No.	Top Diameter	Spout Diameter	Sterile	Material	Quantity per Box
8111H-200	200mm	40mm	No	HDPE	10
8111H-200S	200mm	40mm	Yes	HDPE	10
8111P-350	350mm	50mm	No	PP	TBA
8111P-350S	350mm	50mm	Yes	PP	TBA

* The 350mm size is not moulded in a cleanroom. It is taken into the cleanroom where it is inspected, air cleaned then packed.

SteriWare Tweezers (Forceps)

Tweezers with a Unique Dual Action

The disposable tweezers (forceps) from Sampling Systems are ideal for picking up items up to 25mm wide. The special design means they can pick up both small and large items. Available pre-sterilised as an option for the more demanding applications

- Individually bagged
- FDA and EU 10/2011 conforming material
- Cleanroom manufacture and packing (ensures cleanliness)
- Available from stock for fast delivery worldwide
- Available sterile (SAL 10⁻⁶) and non-sterile



Part No.	Length	Width	Sterile	Material of Construction	Quantity per Box
8025H-115	115mm	10mm	No	HDPE	100
8025H-115S	115mm	10mm	Yes	HDPE	100

Disposable Sack Sampler

Take a sample through the side of a Sack

The disposable Sack Sampler is a hygienic, single use device that has been specially designed to take samples through the side of a sack.

- Individually Bagged
- Made from FDA, EC 1935/2004 & EU 10/2011 Conforming Materials
- BSE/TSE Free
- Full Batch Traceability
- Available sterile (SAL 10⁻⁶) and non-sterile

Operation:

1. Insert the sampler through a sampling hole in the side of the sack.
2. Angle sampler downwards to allow the product to flow into the sample collecting bag
3. Seal hole with an Ultra Adhesive label



Part No.	Length	Diameter	Material	Sterile	Quantity per Box
8085A-100	400mm	25mm	HDPE	No	100
8085A-100S	400mm	25mm	HDPE	Yes	100
8085N-100	400mm	14mm	HDPE	No	100
8085N-100S	400mm	14mm	HDPE	Yes	100
8080A-450	Sample Collecting Bag 450ml - for hygienic use - sterile			Quantity: 1000 bags	
8080A-900	Sample Collecting Bag 900ml - for hygienic use - sterile			Quantity: 1000 bags	

SteriWare® V-Spatula Collection

More Choice For Perfect Sampling



Narrow, Wide, Long or Short - The Choice is Yours for Perfect Sampling



The SteriWare V-Spatula Collection

For Perfect Sampling



The new SteriWare V-Spatula collection offers the widest choice so you can choose the length, shape and design to make sure that your sampling is correct every time.

TWO Designs For Perfect Sampling

V Spatula Type 1
Spatula has an open end

- Ideal for general sampling and dispensing
- Suitable for free flowing and cohesive powders
- Ergonomic handle
- Free standing design



V Spatula Type 2
Spatula has a closed end

- Ideal for sampling a fixed volume and general dispensing
- Suitable for free flowing and cohesive powders
- Ergonomic handle
- Free standing design



- Moulded and packed in a medical Cleanroom
- Made from FDA and EU conforming PS
- BSE/TSE free
- Individually bagged
- Full batch traceability
- Available sterile or non-sterile

SteriWare V-Spatula Type 1



The Type 1 V-Spatula has the traditional open tip design. These spatulas are ideal for dispensing and sampling small quantities.



Narrow - 10mm wide

Part No.	Blade Length	Sterile	Blade Width	Overall Length	Colour	Material	Quantity per Box
8440N-100	100mm	No	10mm	200mm	White	PS	100
8440N-100S	100mm	Yes	10mm	200mm	White	PS	100
8440N-150	150mm	No	10mm	230mm	White	PS	100
8440N-150S	150mm	Yes	10mm	230mm	White	PS	100
8440N-250	250mm	No	10mm	330mm	White	PS	100
8440N-250S	250mm	Yes	10mm	330mm	White	PS	100

Standard - 20mm wide

Part No.	Blade Length	Sterile	Blade Width	Overall Length	Colour	Material	Quantity per Box
8440A-100	100mm	No	20mm	200mm	White	PS	100
8440A-100S	100mm	Yes	20mm	200mm	White	PS	100
8440A-150	150mm	No	20mm	230mm	White	PS	100
8440A-150S	150mm	Yes	20mm	230mm	White	PS	100
8440A-250	250mm	No	20mm	330mm	White	PS	100
8440A-250S	250mm	Yes	20mm	330mm	White	PS	100

SteriWare V-Spatula Type 2



The Type 2 V-Spatula not only has a special closed tip but is designed to be free standing. This means that it is perfect for weighing small quantities of powders and granules.



Narrow - 10mm wide

Part No.	Blade Length	Sterile	Flat Filled Volume	Blade Width	Overall Length	Colour	Material	Quantity per Box
8115N-100	100mm	No	1.5ml	10mm	200mm	White	PS	100
8115N-100S	100mm	Yes	1.5ml	10mm	200mm	White	PS	100
8115N-150	150mm	No	2.5ml	10mm	230mm	White	PS	100
8115N-150S	150mm	Yes	2.5ml	10mm	230mm	White	PS	100
8115N-250	250mm	No	4ml	10mm	330mm	White	PS	100
8115N-250S	250mm	Yes	4ml	10mm	330mm	White	PS	100

Standard - 20mm wide

Part No.	Blade Length	Sterile	Flat Filled Volume	Blade Width	Overall Length	Colour	Material	Quantity per Box
8115A-100	100mm	No	10ml	10mm	200mm	White	PS	100
8115A-100S	100mm	Yes	10ml	10mm	200mm	White	PS	100
8115A-150	150mm	No	15ml	10mm	230mm	White	PS	100
8115A-150S	150mm	Yes	15ml	10mm	230mm	White	PS	100
8115A-250	250mm	No	25ml	10mm	330mm	White	PS	100
8115A-250S	250mm	Yes	25ml	10mm	330mm	White	PS	100

SteriWare® Powder Spatula

Easy to use spatulas - made in a cleanroom



The SteriWare Powder Spatula is one of our most popular single use sampling tools. Sampling and dispensing small quantities of powders has never been easier thanks to the Powder Spatula.

The Powder Spatula is made from robust, shatter-proof polystyrene (PS). The handle is designed to be comfortable to use, even if sampling for several hours.

The Powder Spatula is manufactured and packed in a Cleanroom and so can be used straight from the bag. They are all packed in our ultra strong packaging that is also designed to be easily opened.

Disposables

RED SteriWare® Powder Spatula

Bright red spatulas are highly visible



The SteriWare Red Powder Spatulas offer all the features of our classic white range but they are a highly visible red colour. We use a special food grade red dye to colour the spatulas.

- Top seller
- Available both sterile and non sterile
- Moulded & packed in a class 100,000 Cleanroom
- Each spatula is individually wrapped
- Materials conform to: FDA, EU 10/2011 & EC 1935/2004
- BSE/TSE free
- Available sterile (SAL 10⁻⁶) and non-sterile



Part No.	Blade Length	Colour	Overall Length	Sterile	Material	Quantity per Box
8095R-150	150mm	Red	230mm	No	PS	100
8095R-150S	150mm	Red	230mm	Yes	PS	100
8095R-250	250mm	Red	330mm	No	PS	100
8095R-250S	250mm	Red	330mm	Yes	PS	100

WHITE SteriWare® Powder Spatula

Our best selling spatulas in classic white

White SteriWare Powder Spatulas are made from tough High Impact Polystyrene (PS) and are individually bagged. These high quality spatulas are widely used throughout the pharmaceutical and food industries.

The Powder Spatula is manufactured and packed in a cleanroom, so it can be used straight from the bag.

The Powder Spatula is also available with a special clip-on container, see the PowderSafe on page 56 for details.



- Moulded & Packed in a Cleanroom
- Individually Bagged
- FDA & EU 10/2011 Conforming Materials
- BSE/TSE Free
- Full Batch Traceability
- Available Sterile (gamma irradiated)
- Available in different colours



Part No.	Blade Length	Colour	Overall Length	Sterile	Material	Quantity per Box
8095A-150	150mm	White	230mm	No	PS	100
8095A-150S	150mm	White	230mm	Yes	PS	100
8095A-250	250mm	White	330mm	No	PS	100
8095A-250S	250mm	White	330mm	Yes	PS	100
8095H-150	150mm	White	230mm	No	HDPE	100
8095H-150S	150mm	White	230mm	Yes	HDPE	100

BLUE SteriWare® Powder Spatula

Made From chemically resistant PP



SteriWare blue Powder Spatulas are made from chemically resistant polypropylene (PP) with a bright blue food grade dye. Their bright colour means they can be easily identified if left in the powder (in line with HACCP guidelines).

- Moulded & packed in a class 100,000 Cleanroom
- Each spatula is individually wrapped
- Materials conform to: FDA, EU 10/2011 & EC 1935/2004
- BSE/TSE free
- Made from chemically resistant PP
- Available sterile (SAL 10⁻⁶) and non-sterile



Part No.	Blade Length	Colour	Overall Length	Sterile	Material	Quantity per Box
8095B-150	150mm	Blue	230mm	No	PP	100
8095B-150S	150mm	Blue	230mm	Yes	PP	100
8095B-250	250mm	Blue	330mm	No	PP	100
8095B-250S	250mm	Blue	330mm	Yes	PP	100



Easy To See - the bright colours allow it to be easily seen if left in the powder

New

SteriWare® Cupped Spatulas

Special cupped blade gives superior sampling action

The cupped powder spatula is ideal for powder and granule sampling. The special cupped design means that even very free flowing powders remain in the spatulas.

The cupped spatula is ideal for production, quality checking and raw materials sampling. Robust shatter-proof design.

- Available in 2 convenient lengths.
- Available both non sterile and sterile (SAL 10⁻⁶)
- Moulded & packed in a class 100,000 Cleanroom
- Each spatula is individually wrapped in our high strength, easy to open packaging
- Materials conform to: FDA, EU 10/2011 & EC 1935/2004
- BSE/TSE free
- 5 year shelf life
- Available in bright colours so it can be easily seen if left in the powder

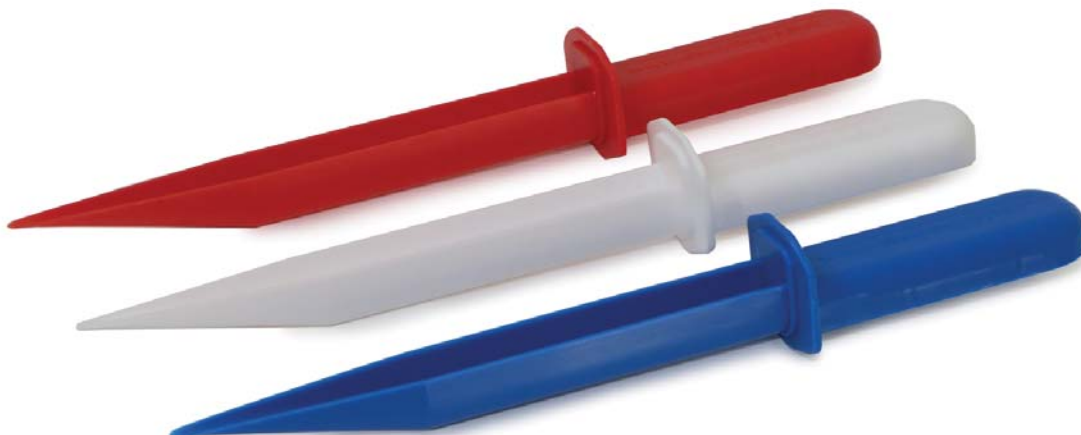
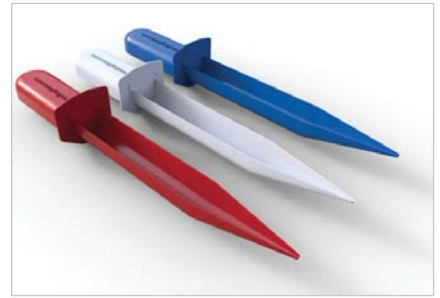

WHITE Cupped Powder Spatula

Individually bagged spatulas with the class leading tip



Part No.	Sterile	Blade Length	Overall Length	Colour	Material	Quantity per Box
8284A-150	No	150mm	230mm	White	PS	100
8284A-150S	Yes	150mm	230mm	White	PS	100
8284A-250	No	250mm	330mm	White	PS	100
8284A-250S	Yes	250mm	330mm	White	PS	100

RED SteriWare® Cupped Spatula

Bright red spatulas are highly visible



Part No.	Sterile	Blade Length	Overall Length	Colour	Material	Quantity per Box
8284R-150	No	150mm	230mm	Red	PS	100
8284R-150S	Yes	150mm	230mm	Red	PS	100
8284R-250	No	250mm	330mm	Red	PS	100
8284R-250S	Yes	250mm	330mm	Red	PS	100

BLUE SteriWare® Cupped Spatula

Made from chemically resistant PP



Part No.	Sterile	Blade Length	Overall Length	Colour	Material	Quantity per Box
8284B-150	No	150mm	230mm	Blue	PP	100
8284B-150S	Yes	150mm	230mm	Blue	PP	100
8284B-250	No	250mm	330mm	Blue	PP	100
8284B-250S	Yes	250mm	330mm	Blue	PP	100

SteriWare® Mono Slot Sampler

Single Point Sampler - 50ml

The disposable Mono Slot Sampler is ideal for taking a single sample from free flowing powders and granules.

The Mono Slot Sampler is designed to take a 50ml sample. The sampling slot is positioned near the tip of the sampler.

- Assembled & Packed in a Cleanroom
- Individually Bagged
- Made from FDA, EC 1935/2004 & EU 10/2011 conforming HDPE
- BSE/TSE Free
- Full Batch Traceability
- Available sterile (SAL 10⁻⁶) and non-sterile

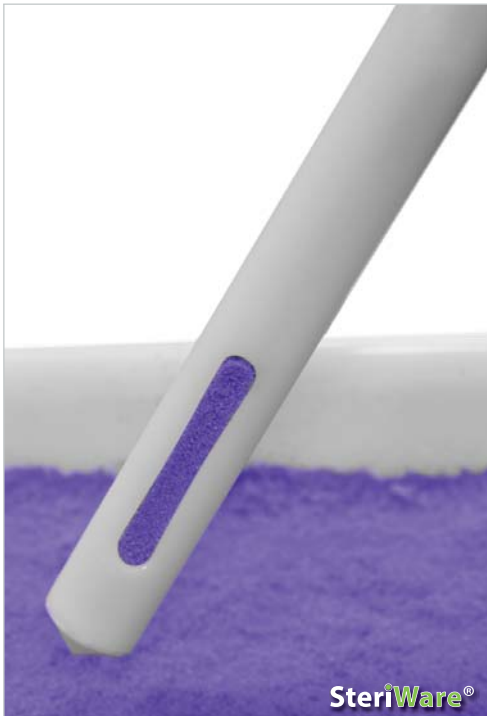
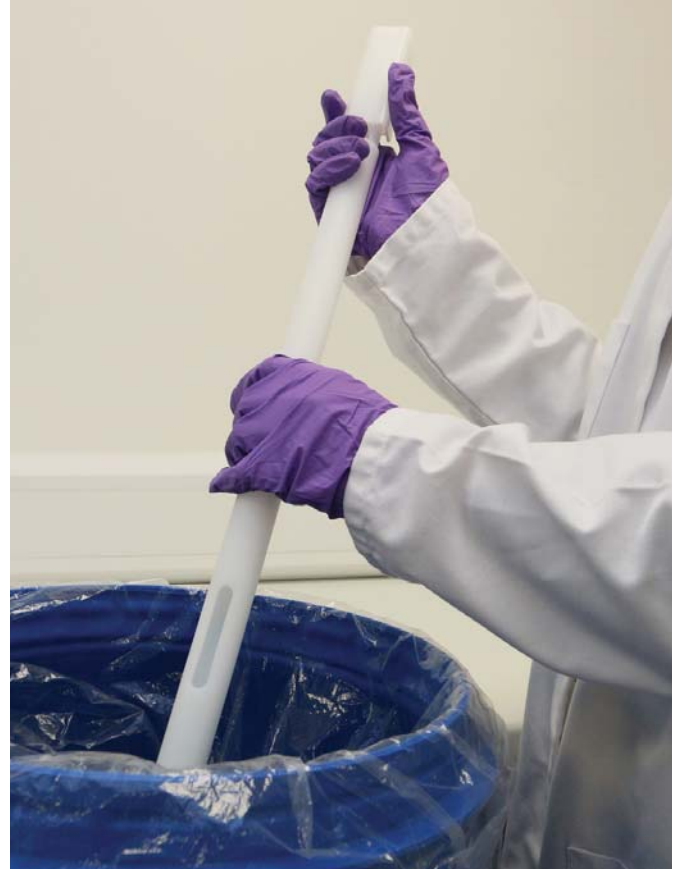

Disposables

Operation

The disposable Mono Slot Sampler is designed for use with free flowing powders and granules:

1. Push the sampler into the product
2. Rotate handle to open up the slot
3. After leaving the sampler for several seconds to allow powder to enter, rotate handle to close the sampler.
4. Remove sampler
5. Slide the inner rod out of the outer tube
6. Deposit the sample into a suitable container

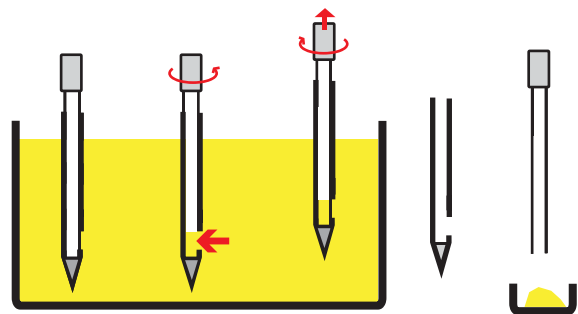

Part No.	Sterile	Overall Length	Nominal Sample Volume	Overall Diameter	Material	Quantity per Box
8069H-500	No	620mm	50ml	26mm	HDPE	20
8069H-500S	Yes	620mm	50ml	26mm	HDPE	20
8069H-1000	No	970mm	50ml	26mm	HDPE	20
8069H-1000S	Yes	970mm	50ml	26mm	HDPE	20

SteriWare® Slot Sampler

Cross Sectional Multilevel Sampler

The disposable Slot Sampler is ideal for taking a multilevel, cross sectional sample from free flowing powders and granules.

The Disposable Slot Sampler takes a single composite sample from the top, middle and bottom of your powder bed.

- Assembled & Packed in a Cleanroom
- Individually Bagged
- Made from FDA, EC 1935/2004 & EU 10/2011 conforming HDPE
- BSE/TSE Free
- Full Batch Traceability
- Available sterile (SAL 10⁻⁶) and non-sterile



Disposables

Operation

The Disposable Slot Sampler is quick and easy to use:

1. Push the sampler into the product
2. Rotate handle to open up slots
3. After leaving the sampler for several seconds to allow powder to enter, rotate handle to close the sampler.
4. Remove sampler
5. Slide the inner rod out of the outer tube
6. Deposit the sample into a suitable container

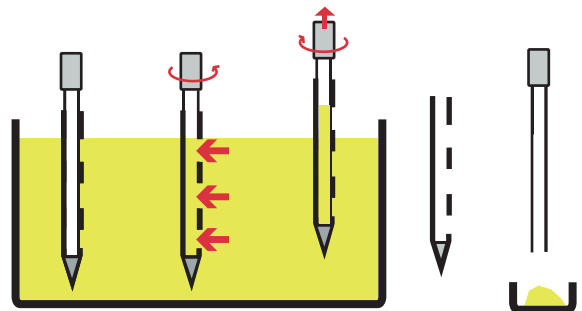

Part No.	Sterile	Overall Length	Nominal Sample Volume	Overall Diameter	Material	Quantity per Box
8073H-500	No	620mm	100ml	26mm	HDPE	20
8073H-500S	Yes	620mm	100ml	26mm	HDPE	20
8073H-1000	No	970mm	170ml	26mm	HDPE	20
8073H-1000S	Yes	970mm	170ml	26mm	HDPE	20
8073J-1000	No	1000mm	500ml	40mm	HDPE	20
8073J-1000S	Yes	1000mm	500ml	40mm	HDPE	20

SteriWare® Powder Probe

Cross Sectional Sampler for Free Flowing Powders

The disposable Powder Probe is ideal for taking a cross sectional sample through a bulk powder. It is similar to the Powder Lance (page 41) but has an additional tip on the end. The Powder Probe is suitable for sampling free flowing powders.

- Assembled & Packed in a Cleanroom
- Individually Bagged
- Made from FDA, EC 1935/2004 & EU 10/2011 conforming HDPE
- BSE/TSE Free
- Full Batch Traceability
- Available sterile (SAL 10⁻⁶) and non-sterile

Operation

The disposable Powder Probe is quick and easy to use:

1. Push the disposable Powder Probe into the product, rotate the sampler and then withdraw
2. Deposit the sample into a suitable container
3. Place the used sampler into its plastic bag



Disposables



Part No.	Sterile	Blade Length	Overall Length	Nominal Sample Volume	Material	Quantity per Box
8064H-500	No	500mm	600mm	125ml	HDPE	20
8064H-500S	Yes	500mm	600mm	125ml	HDPE	20
8064H-1000	No	850mm	950mm	200ml	HDPE	20
8064H-1000S	Yes	850mm	950mm	200ml	HDPE	20

SteriWare® Powder Lance

Cross Sectional Sampler for Cohesive Powders



The open blade of the disposable Powder Lance makes it ideal for taking a cross sectional sample through a sticky cohesive powder.

- Assembled & Packed in a Cleanroom
- Individually Bagged
- Made from FDA, EC 1935/2004 & EU 10/2011 conforming HDPE
- BSE/TSE Free
- Full Batch Traceability
- Available sterile (SAL 10⁻⁶) and non-sterile



Operation

The disposable Powder Lance is quick and easy to use:

1. Push the disposable Powder Lance into the product, rotate the sampler and then withdraw
2. Deposit the sample into a suitable container
3. Place the used sampler into its plastic bag



Part No.	Sterile	Blade Length	Overall Length	Nominal Sample Volume	Material	Quantity per Box
8063H-300	No	300mm	400mm	75ml	HDPE	20
8063H-300S	Yes	300mm	400mm	75ml	HDPE	20
8063H-500	No	500mm	600mm	125ml	HDPE	20
8063H-500S	Yes	500mm	600mm	125ml	HDPE	20
8063H-1000	No	850mm	950mm	200ml	HDPE	20
8063H-1000S	Yes	850mm	950mm	200ml	HDPE	20

SteriWare® Powder Thief

Best Selling Powder Sampler



Disposables

The disposable PowderThief is designed for taking a single sample from a known location within the container. These samplers are available in two convenient lengths and four sample volumes.

The SteriWare PowderThief is suitable for use with free flowing powders and granules.

- Assembled & Packed in a Cleanroom
- Individually Bagged
- Made from FDA, EC 1935/2004 & EU 10/2011 conforming HDPE
- BSE/TSE Free
- Full Batch Traceability
- Available sterile (SAL 10^{-6}) and non-sterile

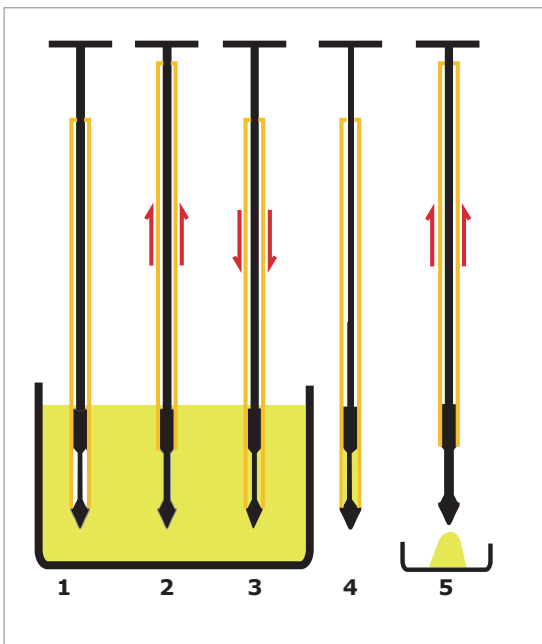

Operation

1. Insert the sampler into the product. Ensure that the tip is inside the sampler body
2. At the required depth pull up the body to expose the tip. The sample will fall in around the tip
3. Push down body of the sampler to trap the sample
4. Withdraw sampler
5. Pull up body to empty sample

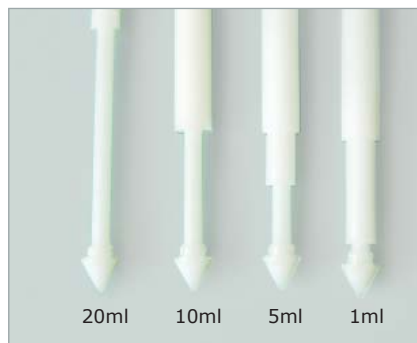

Available with a range of different tip sizes: 1ml, 5ml, 10ml and 20ml



Part No.	Sterile	Nominal Tip Size	Nominal Length	Overall Diameter	Material	Quantity per Box
8060H-501	No	1ml	500mm	21mm	HDPE	20
8060H-501S	Yes	1ml	500mm	21mm	HDPE	20
8060H-505	No	5ml	500mm	21mm	HDPE	20
8060H-505S	Yes	5ml	500mm	21mm	HDPE	20
8060H-510	No	10ml	500mm	21mm	HDPE	20
8060H-510S	Yes	10ml	500mm	21mm	HDPE	20
8060H-520	No	20ml	500mm	21mm	HDPE	20
8060H-520S	Yes	20ml	500mm	21mm	HDPE	20
8060H-1001	No	1ml	1000mm	21mm	HDPE	20
8060H-1001S	Yes	1ml	1000mm	21mm	HDPE	20
8060H-1005	No	5ml	1000mm	21mm	HDPE	20
8060H-1005S	Yes	5ml	1000mm	21mm	HDPE	20
8060H-1010	No	10ml	1000mm	21mm	HDPE	20
8060H-1010S	Yes	10ml	1000mm	21mm	HDPE	20
8060H-1020	No	20ml	1000mm	21mm	HDPE	20
8060H-1020S	Yes	20ml	1000mm	21mm	HDPE	20

Note: Other tip sizes are available between 1 and 20ml - subject to minimum order quantities
1500mm long samplers are available on request - subject to minimum quantities

SteriWare® PowderSafe

Single Use Powder Spatula with a click-on Cover

The PowderSafe comprises of our best selling Powder Spatula complete with a click-on container. The see-through container slips over the blade of the spatula and is securely locked into place.

At the laboratory the cover can be easily removed.

- Moulded & Packed in a Cleanroom
- Individually Bagged
- Made from FDA, EC 1935/2004 & EU 10/2011 conforming Materials
- BSE/TSE Free
- Full Batch Traceability
- Available sterile (SAL 10⁻⁶) and non-sterile



Disposables



Part No.	Blade Length	Overall length	Sterile	Material	Quantity per Box
8097A-150	150mm	230mm	No	PS	100
8097A-150S	150mm	230mm	Yes	PS	100

SteriWare® Batch Traceability

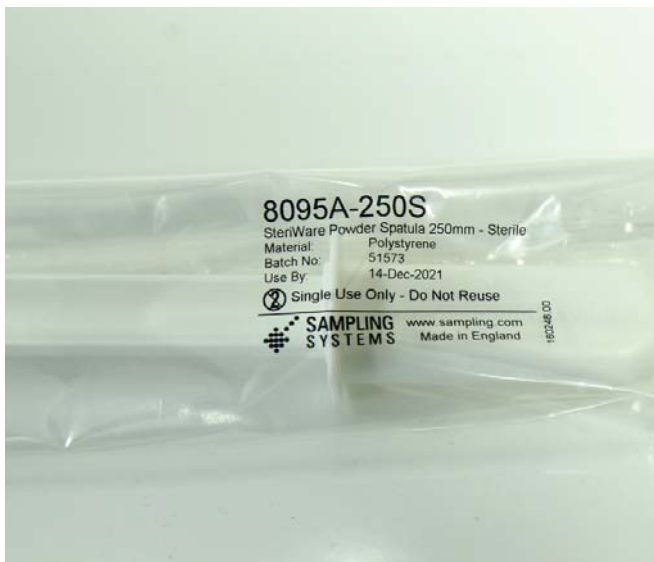

Every SteriWare product comes with a label showing the batch number. This gives us full traceability to the date of manufacture, batch of resin used, machine used, inspected by etc.

Full certification including certificate of conformity and irradiation certification can be downloaded from www.sampling.com.

Batch Traceability

SteriWare® Powder Sampler

Large Volume, single use powder sampler

The disposable Powder Sampler is ideal for taking a single large volume sample from a single known point. The SteriWare Powder Samplers can be used with free flowing powders.

- Assembled & Packed in a Cleanroom
- Individually Bagged
- Made from FDA, EC 1935/2004 & EU 10/2011 conforming HDPE
- BSE/TSE Free
- Full Batch Traceability
- Available sterile (SAL 10⁻⁶) and non-sterile



Operation

The disposable Powder Sampler is quick and easy to use:

1. Push the sampler into the product
2. Rotate handle to open up slots
3. After leaving the sampler for several seconds to allow powder to enter, rotate handle to close the sampler.
4. Remove sampler
5. Deposit the sample into a suitable container

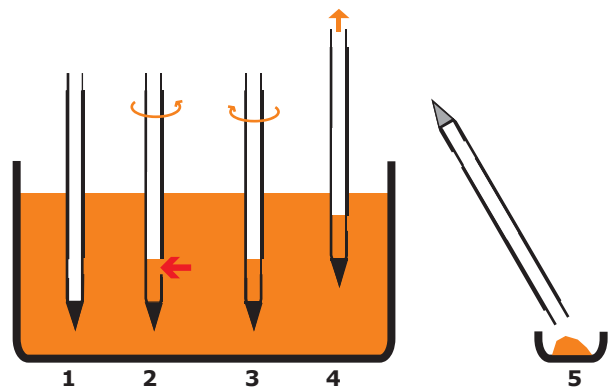

Part No.	Overall Length	Nominal Sample Volume	Sterile	Outer Diameter	Material	Quantity per Box
8240H-1000	1000mm	100ml	No	40mm	HDPE	20
8240H-1000S	1000mm	100ml	Yes	40mm	HDPE	20

SteriWare® LiquiDip
The Self Closing Liquid Sampler

Disposables

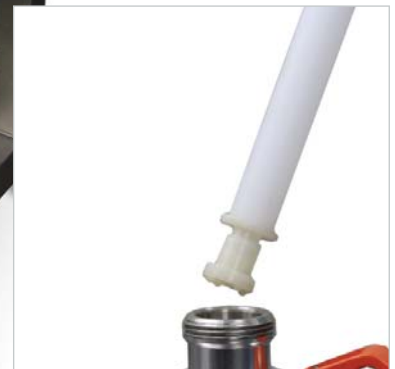

The new LiquiDip sampler from Sampling Systems is ideal for taking cross sectional or point samples of liquids. The special valve on the base of the sampler automatically closes when it is pushed against the bottom of the container.

- Individually bagged
- Made from FDA, EC 1935/2004 & EU 10/2011 conforming materials
- Cleanroom assembly and packing (ensures cleanliness)
- Available from stock for fast delivery worldwide
- No seal required
- Available sterile (SAL 10⁻⁶) and non-sterile

LiquiDip Mono

The LiquiDip Mono is ideal for taking cross sectional samples of low and medium viscosity liquids.

The LiquiDip samplers have special push-to-close valves.

Operation

1. Ensure the valve is in the open position.
2. Push the sampler into the liquid until it reaches the bottom.
3. Push sampler against the container base to close the valve.
4. Remove sampler and pour out the sample.

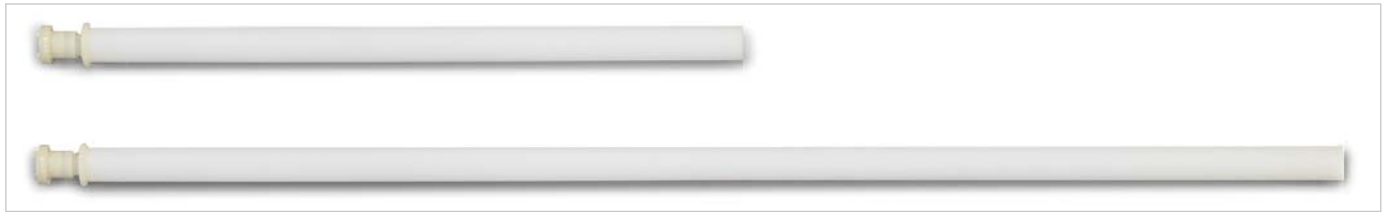
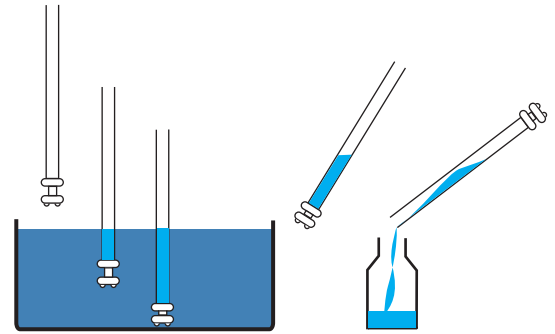

Part No.	Nominal Capacity	Sterile	Length	Material	Quantity per Box
8920H-450	80ml	No	450mm	HDPE	20
8920H-450S	80ml	Yes	450mm	HDPE	20
8920H-1100	225ml	No	1100mm	HDPE	20
8920H-1100S	225ml	Yes	1100mm	HDPE	20

LiquiDip Duo - Both Cross Sectional and Point Sampling

The LiquiDip Duo is a versatile sampler for taking both cross sectional samples and point samples.

Point Sampling -

1. Close the top valve.
2. Push sampler into the liquid to the point required.
3. Open top valve and let liquid flow in.
4. Close top valve and remove sampler

Cross Sectional Sampling -

1. Ensure the top and bottom valves are open
2. Push sampler into the container until it reaches the bottom.
3. Push sampler against the container base to close the valve.
4. Close top valve with hand to ensure liquid is trapped inside

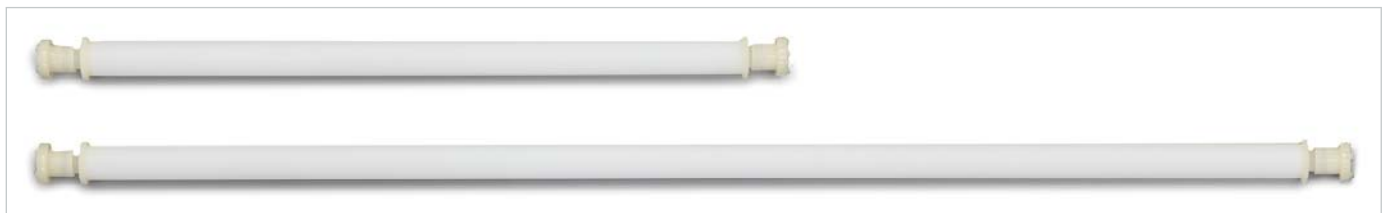
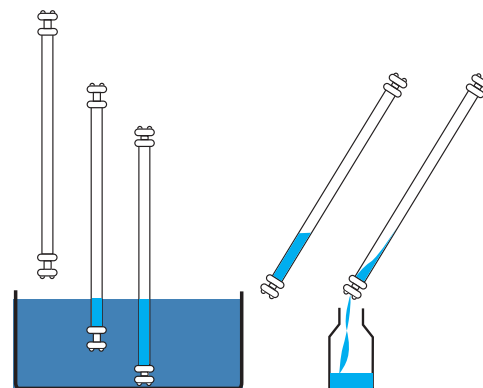
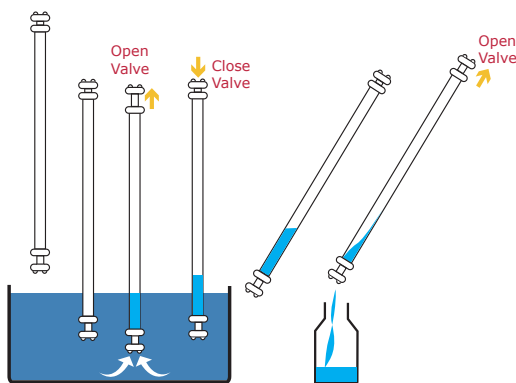

Part No.	Nominal Capacity	Sterile	Length	Material	Quantity per Box
8921H-450	80ml	No	450mm	HDPE	20
8921H-450S	80ml	Yes	450mm	HDPE	20
8921H-1100	225ml	No	1100mm	HDPE	20
8921H-1100S	225ml	Yes	1100mm	HDPE	20

SteriWare® Ladle

Efficient surface sampling of liquids

The SteriWare Ladle is designed to quickly and efficiently take surface samples from liquids. They are moulded and packed in a Cleanroom and so can be used straight from the bag.

The one piece moulded design has been specially made to fit through a standard 2" lid bung. 2" bungs are standard features on many barrels and kegs.

The SteriWare Ladle is ideal for use in production and laboratories. SteriWare Ladles are available either made from natural HDPE or from blue polypropylene (PP).

- Moulded & Packed in a Cleanroom
- Individually Bagged
- Made from FDA, EC 1935/2004 & EU 10/2011 conforming materials
- BSE/TSE Free
- Full Batch Traceability
- Available sterile (SAL 10⁻⁶) and non-sterile
- Available from stock



Disposables



Part No.	Nominal Volume	Diameter	Colour	Sterile	Material of Construction	Quantity per Box
8053H-50	50ml	48mm	Natural	No	HDPE	40
8053H-50S	50ml	48mm	Natural	Yes	HDPE	40
8053B-50	50ml	48mm	Blue	No	PP	40
8053B-50S	50ml	48mm	Blue	Yes	PP	40

SteriWare® LiquiThief

Liquid Sampling Without Costly Cleaning

Sampling Systems revolutionised liquid sampling with the introduction of the LiquiThief. This sampler is ideal for use with low viscosity liquids (e.g. water).

- Assembled & Packed in a Cleanroom
- Individually Bagged
- Made from FDA, EC 1935/2004 & EU 10/2011 conforming materials
- BSE/TSE Free
- Full Batch Traceability
- Available sterile (SAL 10⁻⁶) and non-sterile



Operation:

1. Insert the sampler into the product
2. At the required depth pull up the handle. The sample will be drawn into the sampler
3. Withdraw sampler
4. Push down handle to expel the sample

Note: The further the handle is pulled the greater the sample volume

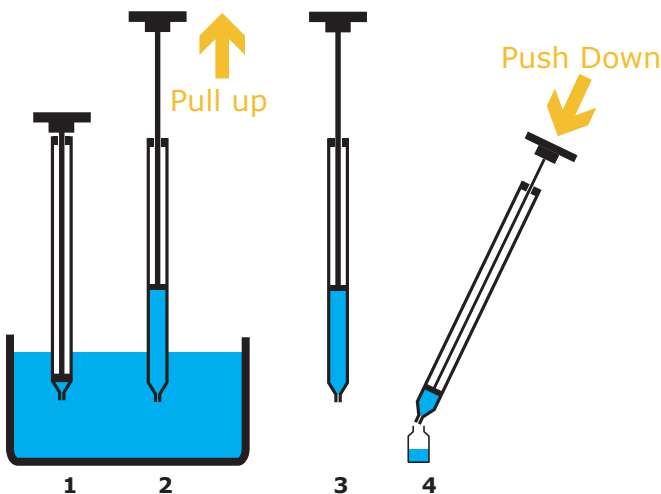

Part No.	Nominal Length	Sterile	Max Sample Volume	Diameter of Hole in Tip	Outer Diameter	Material	Quantity per Box
8050H-500	500mm	No	100ml	1.5mm	21mm	HDPE	20
8050H-500S	500mm	Yes	100ml	1.5mm	21mm	HDPE	20
8050H-1000	1000mm	No	190ml	1.5mm	21mm	HDPE	20
8050H-1000S	1000mm	Yes	190ml	1.5mm	21mm	HDPE	20
8050H-1500	1500mm	No	300ml	1.5mm	21mm	HDPE	20
8050H-1500S	1500mm	Yes	300ml	1.5mm	21mm	HDPE	20
8050P-500	500mm	No	100ml	1.5mm	21mm	PP	20
8050P-1000	1000mm	No	190ml	1.5mm	21mm	PP	20

For high viscosity liquids such as oils and creams see the ViscoThief on page 51

SteriWare® Jumbo Pipettes

Low Cost Disposable Liquid Samplers

SteriWare Jumbo Pipettes are suitable for taking samples from low viscosity liquids (e.g. water).

The 1100mm length sampler is ideal for sampling 200 litre (55 gallon) drums. It means you can reach the bottom of the container but your hand remains clear of the top.

- Assembled & Packed in a Cleanroom
- Individually Bagged
- Made from FDA, EC 1935/2004 & EU 10/2011 conforming HDPE
- BSE/TSE Free
- Full Batch Traceability
- Highly visible colour coded handle
- Available sterile (SAL 10⁻⁶) and non-sterile



SteriWare®

Operation

1. Press thumb onto tube until you are at the correct sampling depth
2. Raise thumb until levels equalize
3. Press thumb onto tube to seal in the sample

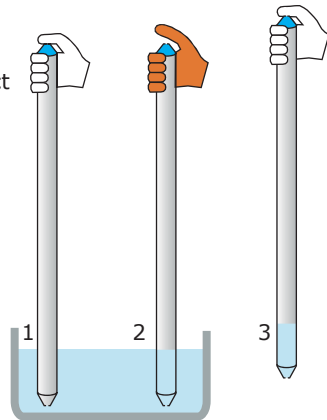

The deeper the sampler is pushed into the liquid the larger the sample volume



Disposables

8051H-1100



8051H-900



8051H-450



A unique feature of the Jumbo Pipette

To avoid handling errors one end of the Jumbo Pipette is colour coded blue.



Part No.	Overall Length	Overall Diameter	Internal Diameter	Sterile	Max. Sample Volume	Material	Quantity per Box
8051H-450	450mm	21mm	17mm	No	80ml	HDPE	50
8051H-450S	450mm	21mm	17mm	Yes	80ml	HDPE	50
8051H-900	900mm	21mm	17mm	No	180ml	HDPE	50
8051H-900S	900mm	21mm	17mm	Yes	180ml	HDPE	50
8051H-1100	1100mm	21mm	17mm	No	225ml	HDPE	37
8051H-1100S	1100mm	21mm	17mm	Yes	225ml	HDPE	37

SteriWare® ViscoThief

Single Use Sampler for High Viscosity Liquids

The Disposable ViscoThief is ideal for sampling viscous materials such as oils, creams, shampoo and honey.

Simple to operate. Takes a sample within seconds.

- Assembled & Packed in a Cleanroom
- Individually Bagged
- Made from FDA, EC 1935/2004 & EU 10/2011 conforming materials
- BSE/TSE Free
- Full Batch Traceability
- Ergonomic handle
- Available sterile (SAL 10⁻⁶) and non-sterile

Operation:

1. Insert the sampler into the product
2. At the required depth pull up the handle. The sample will be drawn into the sampler
3. Withdraw sampler
4. Push down handle to expel the sample

Note: The further the handle is pulled the greater the sample volume

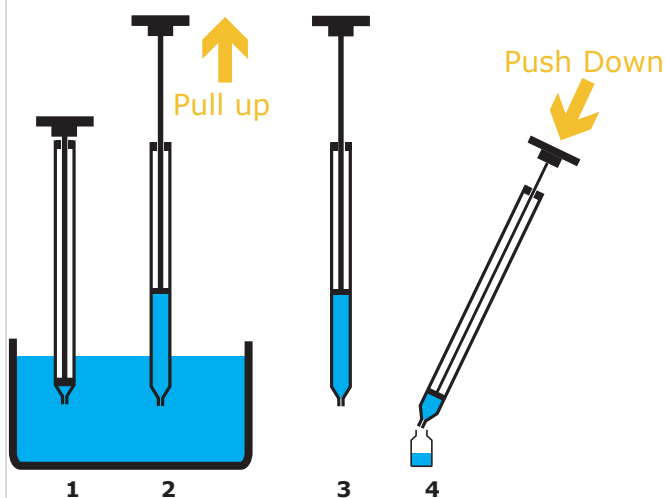

Part No.	Nominal Length	Sterile	Max. Sample Volume	Diameter of Hole in Tip	Outer Diameter	Material	Quantity per Box
8055H-500	500mm	No	100ml	10mm	21mm	HDPE	20
8055H-500S	500mm	Yes	100ml	10mm	21mm	HDPE	20
8055H-1000	1000mm	No	190ml	10mm	21mm	HDPE	20
8055H-1000S	1000mm	Yes	190ml	10mm	21mm	HDPE	20
8055H-1500	1500mm	No	300ml	10mm	21mm	HDPE	20
8055H-1500S	1500mm	Yes	300ml	10mm	21mm	HDPE	20
8055P-500	500mm	No	100ml	10mm	21mm	PP	20
8055P-1000	1000mm	No	190ml	10mm	21mm	PP	20

For low viscosity liquids such as water use the LiquiThief (see page 49)

Thumb Tube Pipettes

Low Cost Disposable Liquid Samplers

Thumb Tube Pipettes are a very quick and easy way of obtaining a liquid sample from a low/medium viscosity liquid.

- Individually Bagged
- Made from FDA, EC 1935/2004 & EU 10/2011 conforming materials
- BSE/TSE Free
- Full Batch Traceability
- Available sterile (SAL 10⁻⁶) and non-sterile

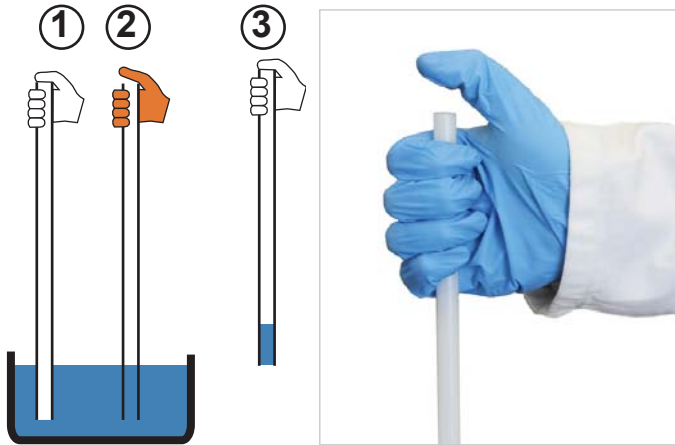

Operation

1. Press thumb onto tube until you are at the sampling depth
2. Raise thumb until levels equalise
3. Cover the end of the tube to seal in the sample



Part No.	Overall Length	Overall Diameter	Internal Diameter	Sterile	Max Sample Volume	Material	Quantity per Box
5055A-50	1000mm	12mm	9mm	No	60ml	HDPE	50
5055A-50S	1000mm	12mm	9mm	Yes	60ml	HDPE	50
5054P-6	300mm	6mm	4mm	No	2ml	PP	100
5054P-8	300mm	8mm	6mm	No	4ml	PP	100

Disposables



SteriWare®

Give us a call for a free sample



Powder Samplers



PowderThief

Best Selling Powder Thief

The PowderThief was originated by Sampling Systems over 25 years ago and is now a world leader in powder sampling. It is extensively used throughout the pharmaceutical, chemical and food industries around the world.

The PowderThief is suitable for sampling free flowing powders and granules. A range of tips is available so that a single sampler body can be used to accurately sample a range of different volumes.

- For sampling free flowing powders
- Made from high quality 316L stainless steel
- Wide range of sizes

Tips - various sizes can be attached to the same body to allow different volumes to be sampled

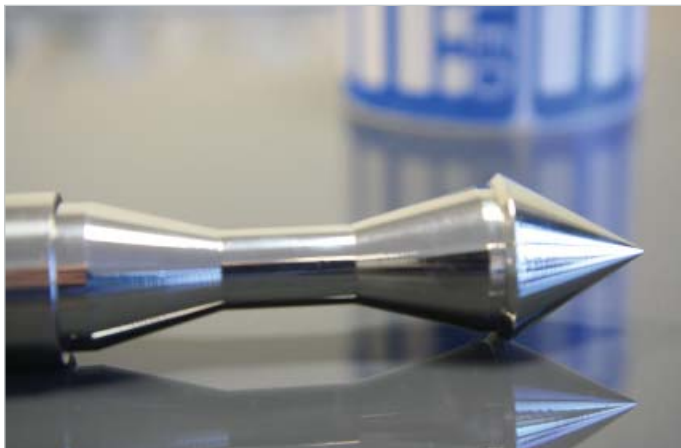

Operation

1. Insert the sampler into the product, ensure that the tip is inside the outer tube.
2. At the required depth pull up the outer tube to expose the tip. Powder will flow in around the tip.
3. Push down the outer tube to trap the sample.
4. Withdraw sampler.
5. Pull up the outer tube to release the sample.

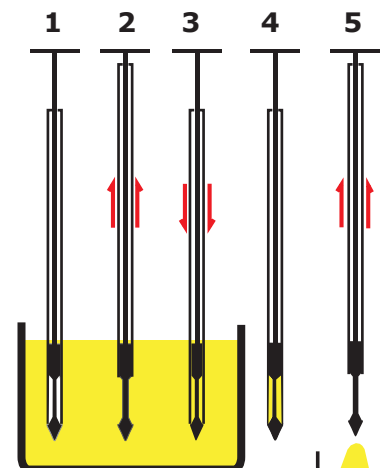



PowderThief samplers are available in a range of different sizes



Sampler Bodies

Part No.	Sampler Length	Body Diameter
1030A-300	300mm	12.5mm
1030A-600	600mm	12.5mm
1030A-1000	1000mm	12.5mm
1030A-1500	1500mm	12.5mm
1030A-2000	2000mm	12.5mm
1030B-600	600mm	19mm
1030B-1000	1000mm	19mm
1030B-1500	1500mm	19mm
1030B-2000	2000mm	19mm
1030C-600	600mm	25mm
1030C-1000	1000mm	25mm
1030C-1500	1500mm	25mm
1030D-600	600mm	32mm
1030D-1000	1000mm	32mm
1030D-1500	1500mm	32mm
1030D-2000	2000mm	32mm

Options Cleaning brushes See page 184
 Storage cases See pages 186-187
 XRF Certification See page 196

Sampling Tips

A range of standard tip sizes is available for each body diameter. Special sizes available on request.

Part No.	Tip Sizes	Tip to suit Body Diameter
1030AT-025	0.25ml	12.5mm
1030AT-050	0.50ml	12.5mm
1030AT-075	0.75ml	12.5mm
1030AT-100	1.00ml	12.5mm
1030AT-150	1.50ml	12.5mm
1030BT-2	2ml	19mm
1030BT-3	3ml	19mm
1030BT-5	5ml	19mm
1030BT-8	8ml	19mm
1030BT-10	10ml	19mm
1030CT-10	10ml	25mm
1030CT-20	20ml	25mm
1030CT-25	25ml	25mm
1030DT-20	20ml	32mm
1030DT-25	25ml	32mm
1030DT-50	50ml	32mm
1030DT-100	100ml	32mm

... also available is a single use, disposable PowderThief

The Disposable PowderThief works in the same way as the stainless steel Powder Thief (above). Disposable samplers have the advantage that they can be used straight from the bag and never need to be cleaned, thereby saving you time and money as well as eliminating the risk of cross contamination.

See pages 42-43 for more information



Mono Pocket Sampler

Single Point Zone Sampler



The Mono Pocket Sampler is ideal for taking bulk samples from a single point. The Mono Pocket Sampler is suitable for sampling free flowing powders and granules.

The robust body is made from 316L stainless steel and is available in 3 convenient lengths.

- For sampling free flowing powders
- Chemically resistant 316L stainless steel construction
- Easy clean design
- Fast delivery anywhere in the world (available from stock)

Operation

The Mono Pocket Sampler is quick and easy to use:

1. Close the sampler by turning the handle.
2. Push into the powder/granules
3. Rotate the handle to open the sampler
4. Close the sampler by rotating the sampler
5. Remove the sampler
6. Transfer sample to bottle or bag



Part No.	Nominal Length	Nominal Sample volume	Sampler Diameter	Material
1430S-600	600mm	20ml	25mm	316L stainless steel
1430S-1000	1000mm	20ml	25mm	316L stainless steel
1430S-1500	1500mm	20ml	25mm	316L stainless steel

Additional Tips	See page 56 (for rounded or very pointed tips)
Cleaning Brushes	See page 184
Storage Cases	See pages 186-187
XRF Certification	See page 196

Additional Tips

Interchangeable tips for stainless steel samplers

Many stainless steel samplers are available with interchangeable tips. Choose the best tip for your product and equipment.

Samplers are supplied with a Standard Tip.

- Standard Tip** Ideal for use with most powders
- Pointed Tip** Use with hard, dense powders
- Rounded Tip** Use when you need to minimise the risk of damaging your equipment



Part No.	Description	To Suit Sampler Diameter	Material
TIP-25S	Standard Tip - 25mm	25mm	316L ss
TIP-25R	Rounded Tip - 25mm	25mm	316L ss
TIP-25P	Long Pointed Tip - 25mm	25mm	316L ss
TIP-40S	Standard Tip - 40mm	40mm	316L ss
TIP-40R	Rounded Tip - 40mm	40mm	316L ss
TIP-40P	Long Pointed Tip - 40mm	40mm	316L ss

Sleeve Sampler

Large Volume Sampling From Depth

The Sleeve Sampler is ideal for sampling large volumes at great depths. The Sleeve Sampler is suitable for sampling free flowing powders and granules.

Various sized chambers can be attached to the same handle to allow different sample volumes to be taken.

- Single Point Sampler
- Suitable for sampling free flowing powders
- 316L stainless steel, bright finish
- Adjustable Length - use extension rods to make the sampler the length you require

The heavy duty handle and extension rods have been designed to be extremely strong and robust to allow samples to be taken from depths up to 6m (after about 6m the sampler becomes too heavy).



Operation:

1. Screw the Sample Chamber onto the handle and insert the sampler into the product.
2. At the required depth pull up the sampler slightly. This will force the sleeve down so that product can fall into the Sample Chamber.
3. Remove sampler.
4. To empty sampler either pour sample out of filling port or unscrew the tip.

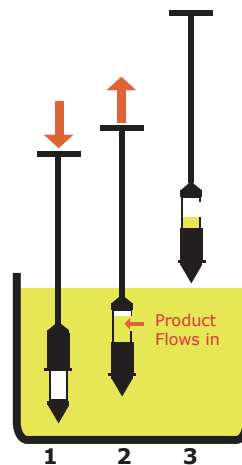

Powders Single Level Sampling



Use extension rods (1035E-1000 or 1035E-1500) to increase the reach of the sampler



Handles & Extension Rods		
Part No.	Description	Length
1035A-1000	Heavy Duty Handle - 316L ss	1000mm
1035A-1500	Heavy Duty Handle - 316L ss	1500mm
1035E-1000	Heavy Duty Extension Rod - 316L ss	1000mm
1035E-1500	Heavy Duty Extension Rod - 316L ss	1500mm

Sample Chambers		
Part No.	Material	Chamber Volume
1035T-100	316L ss	100ml
1035T-150	316L ss	150ml
1035T-200	316L ss	200ml

Storage Cases	See pages 186-187
XRF Certification	See page 196

Point Sampler

Large Volume Sampling from a set point

The Point Sampler from Sampling Systems is ideal for taking samples at a specified depth. It can be used for sampling both free flowing and sticky, cohesive powders.

- Large 100ml sample size
- 316L stainless steel
- Suitable for use with free flowing and cohesive powders

Operation

1. Ensure the sampling window is closed and then push sampler into the product to the required sampling depth
2. Rotate sampler through 360° - this will open the sampling window and push the surrounding product into the sample collecting chamber
3. Rotate the sampler backwards through 360° to close the sampling window
4. Withdraw the sampler



Part No.	Handle Length	Nominal Sample Volume	Material
1640A-1000	1000mm	100ml	316L stainless steel
1640A-2000	2000mm	100ml	316L stainless steel

Stainless Spoons 316L ss



- 316L stainless steel construction
- Crevice free
- Bowl & flat ends
- Satin finish



Part No.	Nominal Bowl Volume	Nominal Overall Length	Material
A506-300	10ml	300mm	316L stainless steel
A506-600	10ml	600mm	316L stainless steel
A506-1000	10ml	1000mm	316L stainless steel



Silo Rocket Sampler

500ml Sampler from Depth

Bulk sampling is easy with the Silo Rocket. The Silo Sampler is ideal for sampling pharmaceuticals, cosmetics and food stuffs. The design allows rapid point sampling of powders and granules in silos, tankers, lorries and general bulk bins. To take a sample simply insert the sampler into your material and then rotate the handle to take the sample. After sampling remove the sampler.

The Silo Rocket is manufactured from high grade 316L stainless steel. The tip unscrews so that the sampler is easy to clean

The Silo Rocket has an extra wide handle to give sufficient leverage when sampling dense powders.

- Suitable for use with free flowing and cohesive powders
- Made from 316L stainless steel
- Available in different lengths
- Easy to clean
- Available from stock for fast delivery worldwide

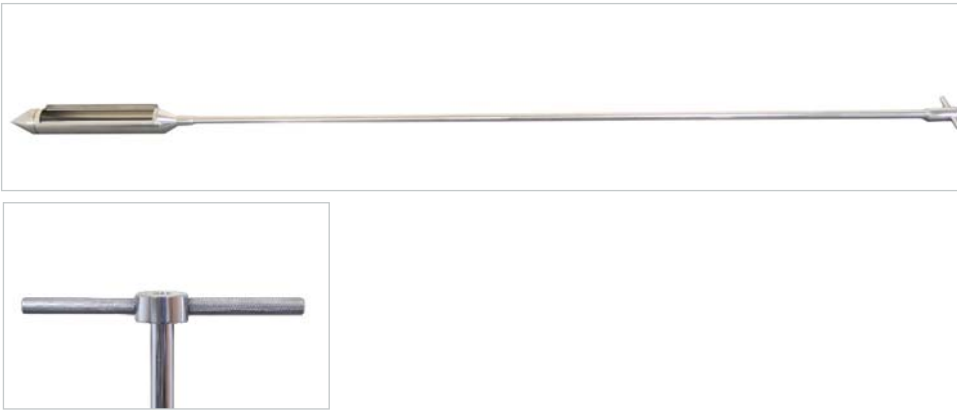

Part No.	Handle Length	Nominal Volume	Material
1985A-1000	1000mm	500ml	316L ss
1985A-1500	1500mm	500ml	316L ss
1985A-2000	2000mm	500ml	316L ss

The world's largest range of stainless steel scoops

See pages 154-159 for more information



Sack Master

The World's Best Range of High Quality Sack Samplers



The Sampling Systems Sack Master range has been specially designed to take samples through the side of a sack.

A unique range of sample collection methods are available.

- Single point sampler
- Suitable for sampling free flowing powders and granules
- 316L stainless steel or HDPE

Operation:

1. Insert the sampler through the side of the sack.
2. Angle sampler downwards to allow the product to flow into the sample collecting container
3. Seal the hole using an Ultra Adhesive label (see pages 189-195).

A. Sack Sampler with Plain End

- Sample collecting bag is held over end of sampler
- Plain end



Part No.	Length	Diameter	End Fitting
1320A-01	400mm	25mm	Plain



B. Sack Sampler with End Cap

- Cap screws on to end of Sack Sampler
- Easily removed for cleaning
- Sample is retained in Sack Sampler



Part No.	Length	Diameter	End Fitting
1320B-01	420mm	25mm	End Cap



C. Sack Sampler with Bottle Adapter

- Adapter screws on to end of Sack Sampler
- Sample is collected in either a 250ml or 500ml bottle
- After sampling unscrew bottle and screw on the plastic bottle cap



Part No.	Length	Diameter	End Fitting
1320C-01	420mm	25mm	Bottle Adapter*

* Sampler supplied with one 250ml Sample Bottle (Part no. 8165A-250)

8165A-250	250ml Bottle HDPE
8165A-500	500ml Bottle HDPE





Jumbo Sack Sampler

Wide diameter Sack Samplers

Our new range of Jumbo Sack Samplers have been introduced to meet the demand of sampling larger items such as nuts, grains and larger granules from sacks.

The Jumbo sack samplers are available in 2 lengths and 3 different styles:

- Suitable for sampling free flowing powders and granules
- Plain style - Simply hold over a bag
- End Cap - The sample is held in the sampler until the sample is deposited
- Bottle adapter - Sample drops straight into the bottle

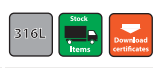

Part No.	Length	Diameter	End Fitting	Material
1309A-400	400mm	40mm	Plain	316L ss
1309B-400	400mm	40mm	End Cap	316L ss
1309C-400	400mm	40mm	Bottle Adapter	316L ss
1309A-800	800mm	40mm	Plain	316L ss
1309B-800	800mm	40mm	End Cap	316L ss
1309C-800	800mm	40mm	Bottle Adapter	316L ss



1309C-400 and 1309C-800 are supplied with a 1000ml sample bottle (spare bottle part no. 8126H-1000).

Disposable Sack Sampler

Pre-Sterilised Disposable Samplers

The disposable Sack Sampler is a hygienic, single use device that has been specially designed to take samples through the side of a sack.

- Suitable for sampling free flowing powders and granules
- Individually Bagged
- FDA & EU 10/2011 Conforming Materials
- BSE/TSE Free
- Full Batch Traceability
- Available Sterile (gamma irradiated)

Operation:

1. Insert the sampler through the side of the sack.
2. Angle sampler downwards to allow the product to flow into the sample collecting bag
3. Seal the hole with an Ultra Adhesive label (see pages 189-195)



Part No.	Length	Diameter	Material	Sterile	Quantity per Box
8085A-100	400mm	25mm	HDPE	No	100
8085A-100S	400mm	25mm	HDPE	Yes	100
8085N-100	400mm	14mm	HDPE	No	100
8085N-100S	400mm	14mm	HDPE	Yes	100
8080A-450	Sample Collecting Bag 450ml - for hygienic use - sterile			Qty: 1000 bags	
8080A-900	Sample Collecting Bag 900ml - for hygienic use - sterile			Qty: 1000 bags	

Powder Max

Large volume sleeve sampler

Designed for use with free flowing powders, granules and grains. The Powder Max enables large samples to be quickly and easily taken.

The Powder Max is made from 316L stainless steel.

- Large 150ml sample size
- 316L stainless steel
- Suitable for use with free flowing powders and granules

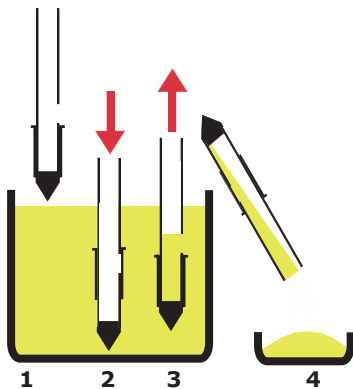

Operation

1. Insert sampler into the product.
2. This action forces the sleeve upwards covering the sample hole and stopping powder from entering.
3. On pulling the sampler upwards, the sleeve moves down and the product can now enter the sampler.
4. Invert sampler to discharge the sample.



Part No.	Overall Length	Stainless Steel	Diameter	Max Sample Volume
1213A-01	1000mm	316L ss	40mm	150ml
Accessories	Cleaning brushes	See page 184		
	Storage Cases	See pages 186-187		
	XRF Certification	See page 196		



Do You Need Specification Sheets?

Specifications sheets for every product can now be downloaded from www.sampling.com

Telescopic Powder Sampler

Take Powder Samples up to 6m Deep

The Telescopic Powder Sampler is designed for use with free flowing powders, granules and grains. The handle can be quickly and easily extended to the desired length. The Telescopic Powder Sampler enables samples to be quickly and easily taken from depths of up to 6m.

- Telescopic rod extends up to 6m
- Range of different sized sample collecting Chambers
- 316L stainless steel construction with PTFE clutch

Operation

1. Insert sampler into the product.
2. This action forces the sleeve upwards covering the sample hole and stopping powder from entering.
3. On pulling the sampler upwards, the sleeve moves down and the product can now enter the sampler.
4. Withdraw the sampler.
5. Pull sleeve back to discharge powder

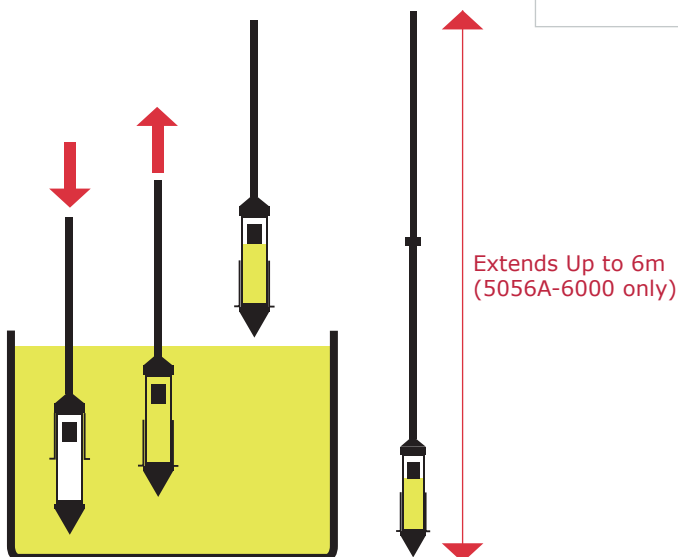

Telescopic sampler ideal for sampling large depths



Telescopic Handles		
Part No.	Length	Material of Construction
5065S-1500	800 to 1500mm	316L stainless steel & PTFE
5065S-3000	1500 to 3000mm	316L stainless steel & PTFE
5065S-4500	1500 to 4500mm	316L stainless steel & PTFE
5065A-1200	600 to 1200mm	Aluminium & Plastic
5065A-2500	1250 to 2500mm	Aluminium & Plastic
5065A-2800	1020 to 3000mm	Aluminium & Plastic
5065A-3000	1000 to 3000mm	Aluminium & Plastic
5065A-4500	1500 to 4500mm	Aluminium & Plastic
5065A-6000	1500 to 6000mm	Aluminium & Plastic
Storage Cases	See pages 186-187	
XRF Certification	See page 196	

Sample Chambers		
Part No.	Chamber Volume	Material
1035P-001	1ml	316L stainless steel
1035P-002	2ml	316L stainless steel
1035P-100	100ml	316L stainless steel
1035P-150	150ml	316L stainless steel
1035P-200	200ml	316L stainless steel

Special volumes available on request.

MicroThief

Ultra Low Volume Powder Thief

The MicroThief is suitable for taking very small volume samples of free flowing powders and granules. The MicroThief is easily adjusted so that the operator can vary the size of the sample being taken.

- Made from high quality 316L stainless steel
- Adjustable - takes a range of sample sizes
- Simple to use

Operation

1. Insert the sampler into the product, ensure that the tip is inside the sampler body.
2. At the required depth pull up the body to expose the tip. Powder will flow in around the tip.
3. Push down body of the sampler to trap the sample.
4. Withdraw sampler.
5. Pull up body to release the sample.

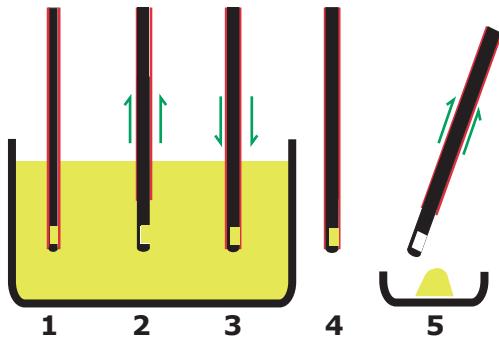

Part No.	Nominal Sample Volume	Max. Sampling Depth	Material	Overall Diameter
1074A-350	Variable between 0.01 and 0.1ml	350mm	316L ss	5mm
1074A-500	Variable between 0.01 and 0.1ml	500mm	316L ss	5mm

Storage Cases See pages 186-187

XRF Certification See page 196

MicroMate

Ultra Low Volume Powder Sampler

The MicroMate is designed for low volume sampling of free flowing powders and granules. It is ideal for very low volume unit dose sampling.

The MicroMate can be easily adjusted so that it can take a range of sample sizes.

- Made from high quality 316L stainless steel
- Adjustable - takes a range of sizes
- Simple to use

Operation

1. Insert the sampler into the product. Ensure that the inner rod extends beyond the outer tube.
2. At the required depth pull up the inner rod to draw the product into the sampler.
3. Withdraw sampler.
4. Push down handle to release sample

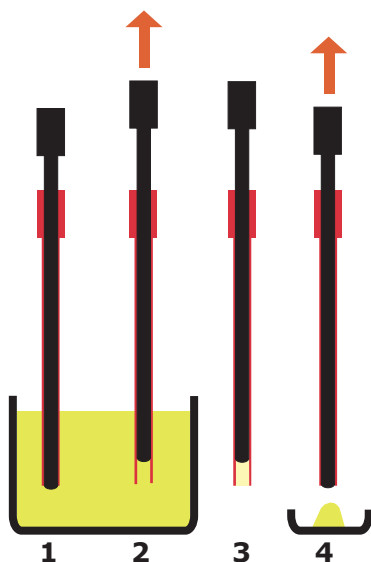

1070A-350



Part No.	Nominal Sample Volume	Max. Sampling Depth	Material	Overall Diameter
1070A-350	Variable - up to 0.1ml	350mm	316L ss	5mm
1070A-500	Variable - up to 0.1ml	500mm	316L ss	5mm

Storage Cases See pages 186-187

XRF Certification See page 196

Measuring Scoop

Accurately Measures Powders

Sampling Systems' Measuring Scoops are ideal for measuring fixed volumes of powder. They are made from high quality 316L stainless steel.

Special volumes are available on request.

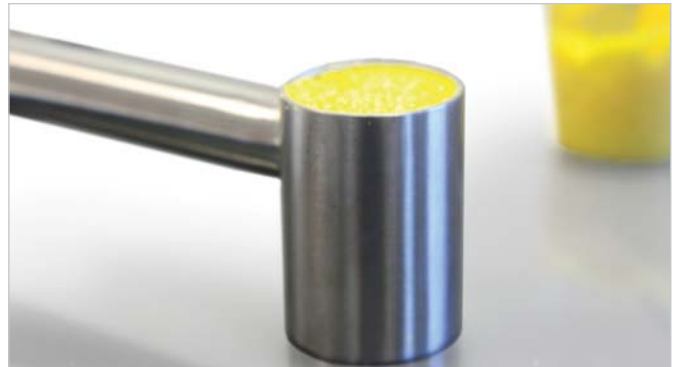
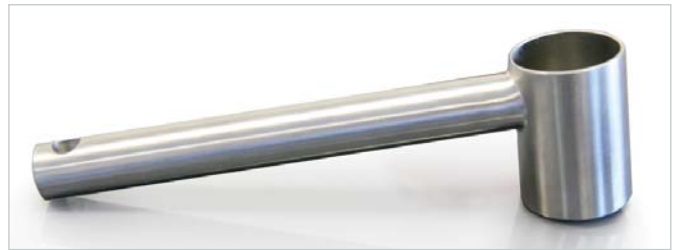

Part No.	Volume of Scoop	Scoop Diameter	Scoop Depth	Overall Length	Material of Construction
1900A-01	1ml	9mm	14mm	186mm	316L ss
1900A-05	5ml	22mm	13mm	193mm	316L ss
1900A-10	10ml	22mm	26mm	193mm	316L ss
1900A-25	25ml	35mm	26mm	199mm	316L ss
1900A-50	50ml	35mm	52mm	199mm	316L ss

Please note these are not certified measuring containers. Contact us for more information

Cement Sampler

Quickly and easily take samples from tankers

The lightweight cement sampler is the ideal choice when you are looking to quickly take a sample throughout a tanker.

- Lightweight
- Easy to use
- Cross sectional sample
- Patented design
- 2m long



The Cement Sampler allows fast sampling from tankers etc. It was designed for the cement industry but can be used on a wide range of free flowing powders .

The sample is a cross section through the tanker(from top to bottom). The sample size is approximately 8 litres from a bulk depth of 1.5 metres.

Easy handling: The open tube will penetrate the product to the desired depth. When retracting the patented valve is closed and the sample inside the tube can be withdrawn.

The cement sampler is suitable for free flowing powders with a bulk weight of approximately 1 kg/litre.



Part No.	Material of Construction	Outside Diameter	Weight	Maximum Sampler Volume	Sampler Length
1120A-01	PP & stainless steel	90mm	1.5kg	8 litres	2000mm

Note: The cement sampler is not suitable for hygienic GMP sampling

U-D Sleeve Sampler

The Accurate Unit Dose Powder Sampler

The U-D Sleeve Sampler is extensively used in the pharmaceutical industry for accurate, small volume sampling of free flowing powders and granules. It is ideal for Unit Dose Sampling.

- Single Point Unit Dose Sampler
- Suitable for use with free flowing powders and granules
- 316L stainless steel
- Use extension rods to increase the length of the sampler

Operation

1. Insert the sampler into the product.
2. At the required depth pull up the sampler slightly (this upwards action will force the sleeve down the sample chamber and expose the ports) the product can then fall into the sample chamber.
3. As the sampler is removed the excess powder will fall out of the overflow leaving an accurate volume of powder in the sample chamber.



U-D Sleeve Sampler Set (1500S-01) - The set includes a range of 10 interchangeable tips to allow different sample volumes to be taken. Extension rods allow samples to be taken from a depth of up to 3m.

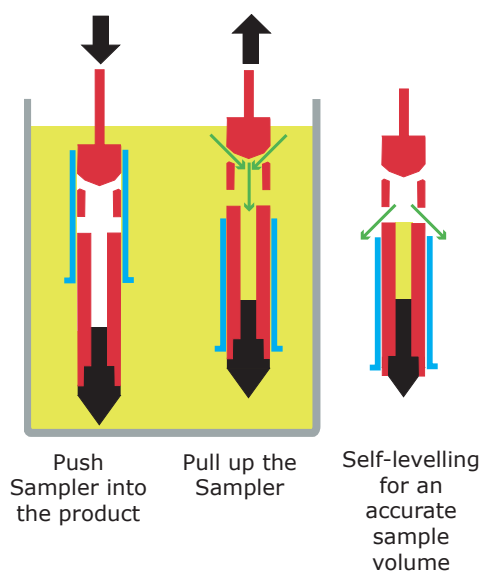

Different Volume Sampling Tips can be fitted to the same chamber



Part No.	Description
1500S-01	U-D Sleeve Sampler Set
	Includes: 1 x T-bar handle - 600mm 4 x handle extension rods - 600mm 1 x Type 1 sample chamber (for Tips 0.1 to 1.2ml)
	1 x Type 2 sample chamber (for Tips 1.3 to 2.5ml) 10 x Sampling tips* (0.1ml to 2.5ml - see below) 1 x High Quality Sampler Case - lockable
1500A-01	T Bar Handle 600mm
1500A-02	Handle Extension 600mm
1500A-03	Sample Chamber - Type 1 (for Tips 0.1 to 1.2ml)
1500A-04	Sample Chamber - Type 2 (for Tips 1.3 to 2.5ml)
1500C-01	High Quality Sampler Case - lockable - with cut outs for sampler components
XRF Certification	XRF Certification (See page 196)
Sampling Tips	
Tips are available in all sizes from 0.1ml to 2.5ml in 0.1ml increments. (0.1ml, 0.2ml, 0.3ml, 0.4ml etc.)	
How to Order a Tip:	
Use part number Example:	1500W-XX where XX is the tip size 1500W-07 0.7ml tip 1500W-23 2.3ml tip

* When ordering 1500S-01 please list the ten Sampling Tips that you require

U-D Cohesive Sampler

Unit Dose Sampler for Cohesive Powders

A popular sampler in the pharmaceutical industry for taking low volume (unit dose) cohesive powder samples. Allows accurate samples to be taken.

- Single Point Unit Dose
- 316L stainless steel
- Suitable for use with sticky, cohesive powders



Operation

1. Insert the sampler into the product.
2. At the required depth push down the handle and rotate it through 180°.
3. Pull up sampler slightly (to fill the cell), then rotate handle 180° (to lock cell in closed position).
4. Remove sampler

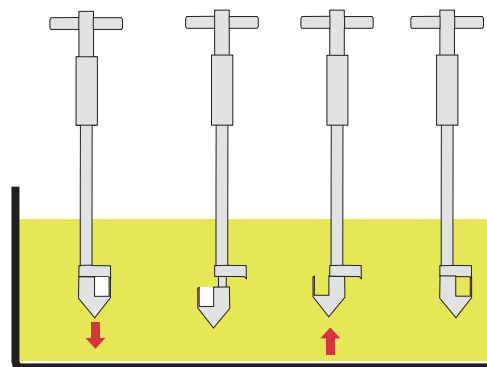

Sample Collecting Cells are available in a range of standard sizes.



2000T-25



2000T-50



2000T-75



2000T-100



Part No.	Description
2000S-01	U-D Cohesive Sampler Set - consisting of: 1 off Handle, Sample Cells - 1 each of: 0.25ml, 0.5ml, 0.75ml and 1.0ml 1 off Standard Sampler Case
2000A-1000	Sampler body with 1000mm handle length - 316L ss
2000T-025	Sample Collecting Cell 0.25ml - 316L ss
2000T-050	Sample Collecting Cell 0.5ml - 316L ss
2000T-075	Sample Collecting Cell 0.75ml - 316L ss
2000T-100	Sample Collecting Cell 1.0ml - 316L ss
8020N-1100	Cleaning Brush - 1100mm length - narrow style
	Storage Cases - see pages 186-187
	XRF Certification - See page 196

Multi Thief

Multilevel Powder Sampler with variable Sample Volumes

The Multi Thief is ideal for taking multilevel samples from free flowing powders and granules.

The sample volume can be quickly and easily changed by changing removable sample cells.

- 316L stainless steel construction
- Variable sample volumes 5ml to 60ml
- Range of sampler lengths
- Suitable for free flowing powders and granules



Operation:

1. Select the correct volume inserts and fit them into the inner rod.
2. Slide the assembled inner rod into the outer tube
3. Insert the sampler into the product, turn the handle to expose the sampling cells to the product.
4. Turn the handle so no sampling inserts are exposed then remove the sampler from the product.
5. Remove the inner rod from the outer sleeve, the individual Sampling Inserts can then be easily removed for analysis.

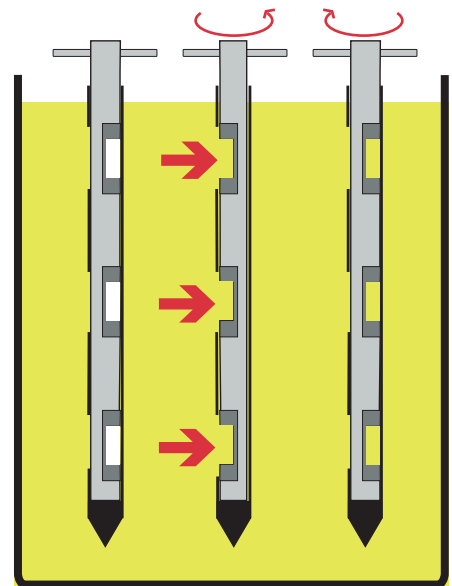

Part No.	Sampler Length	Diameter	No. of Inserts Required	Material of Construction
1290K-1000	1000mm	40mm	3	316L stainless steel
1290K-1500	1500mm	40mm	4	316L stainless steel
1290K-2000	2000mm	40mm	4	316L stainless steel

Sample Inserts

Inserts are available any volume from 5ml up to 60ml

1290W-XX Sample Insert where XX = sample volume in ml e.g. 1290W-25 = insert with 25ml sample volume

Additional Tips See page 56 (for rounded or very pointed tips)

Cleaning Brushes See page 184

Storage Cases See pages 186-187

XRF Certification See page 196

Slot Sampler

Multilevel Sampler gives a Single Composite Sample



Slot Samplers are supplied with pointed tips. Rounded Tips are available as an option.



A Slot Sampler taking a sample from a drum

The Slot Sampler is ideal for taking a large volume, cross sectional sample from a container. The sampler has a robust all stainless steel construction and is suitable for sampling free flowing powders and granules.

- Cross section, composite sample
- Suitable for taking large volume samples



Operation:

1. Insert the sampler into the product
2. Turn the handle to open the slot - the product can now be collected in the central tube
3. Turn the handle to close the slot
4. Remove the sampler
5. Invert the sampler to discharge the sample

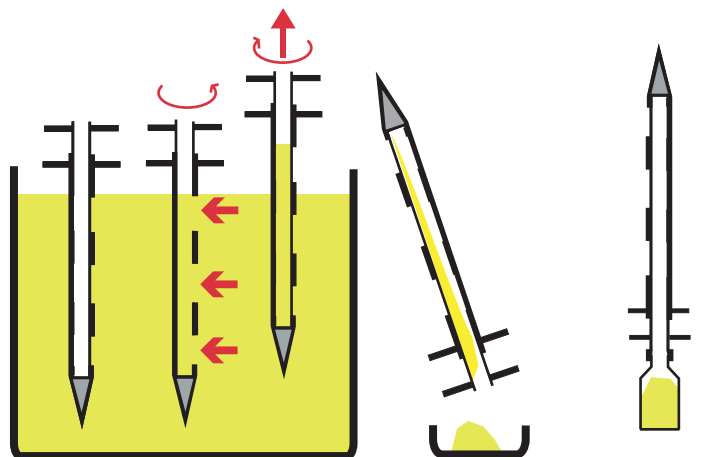

Emptying from standard Sampler

Emptying from sampler with a bottle adapter



The Slot Sampler is available with a bottle holder. This enables the sample to be emptied directly into a bottle.



Sample being discharged from a Standard Slot Sampler without a Bottle Holder

- Improved Containment
- Save time
- Can be used with either a 250ml or 500ml bottle



Part No.	Bottle Holder	Sampler Length	Outer Diameter	Material	Maximum Sample Volume	No of Slots
1210A-300	No	300mm	25mm	316L stainless steel	45ml	3
1210A-600	No	600mm	25mm	316L stainless steel	110ml	3
1210A-1000	No	1000mm	25mm	316L stainless steel	190ml	4
1210A-1500	No	1500mm	25mm	316L stainless steel	300ml	5
1210A-2000	No	2000mm	25mm	316L stainless steel	370ml	5
1210B-600	Yes*	600mm	25mm	316L stainless steel	110ml	3
1210B-1000	Yes*	1000mm	25mm	316L stainless steel	190ml	4
1210B-1500	Yes*	1500mm	25mm	316L stainless steel	300ml	5
1210K-1000	No	1000mm	40mm	316L stainless steel	750ml	3
1210K-1500	No	1500mm	40mm	316L stainless steel	1000ml	4
1210K-2000	No	2000mm	40mm	316L stainless steel	1300ml	4
1210J-900	No	900mm	50mm	Aluminium	880ml	3
1210J-1500	No	1500mm	50mm	Aluminium	1700ml	5
1210J-2500	No	2500mm	50mm	Aluminium	2900ml	7
8165A-250	Sample collecting bottle - 250ml. HDPE					
8165A-500	Sample collecting bottle - 500ml. HDPE					

Additional Tips	See page 56 (for rounded or very pointed tips)
Cleaning brushes	See page 184
Storage Cases	See pages 186-187
XRF	Material certification verified by XRF (See page 196)
* Don` t forget to order a sample collecting bottle	

See page 39 for **Disposable Slot Samplers**



Pocket Sampler

Multilevel Sampler for taking discrete samples

The Pocket Sampler is used in thousands of pharmaceutical and industrial manufacturing facilities all over the world. The Pocket Sampler is ideal for taking discrete samples from free flowing powders and granules. The sampler is available in a range of sizes and designs.

Its robust stainless steel design means it will give years of service.

Operation:

1. Insert the sampler into the product
2. At the required depth rotate handle to expose the collecting pockets, the product will flow into the collecting pockets
3. Rotate handle to close pockets and remove sampler
4. See below for details on how to empty the sampler

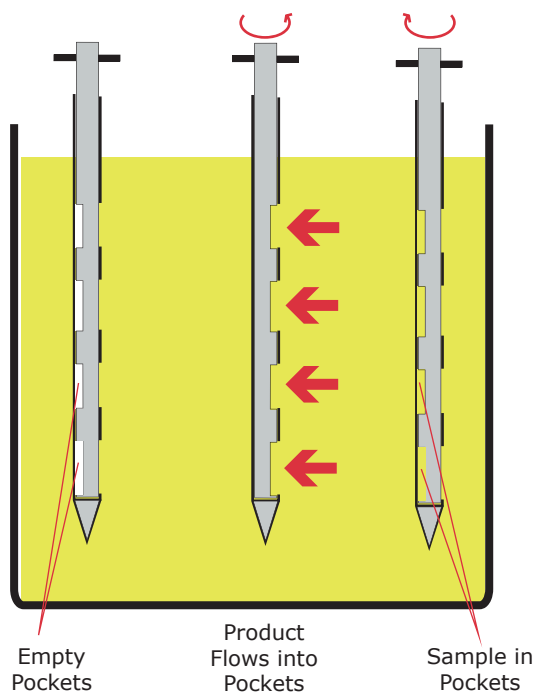

Emptying Rack

- Enables the samples to be deposited directly into collecting bottles
- All stainless steel construction
- Supplied complete with stainless steel funnels



Bayonet Handle

- Allows simple operation
- Quick disconnect system so sampler can be dismantled in seconds.
- Robust design

(Bayonet handle is available on the 1220A and 1220B models)

Sealing Sleeves

- Enables one pocket to be emptied at a time
- Simply clip on to cover the pockets that you do not want to empty
- Easy to remove

Tips

- Samplers are supplied with pointed tips as standard
- Rounded tips are available as an option



Part No.	Outer Tube	Inner Rod	Outer Diameter	Number of Pockets	Volume of each Pocket	Sampler Length
1220A-600	316L stainless	PTFE	25mm	3	15ml	600mm
1220A-900	316L stainless	PTFE	25mm	3	20ml	900mm
1220A-1500	316L stainless	PTFE	25mm	5	20ml	1500mm
1220B-300	316L stainless	316L stainless	25mm	3	10ml	300mm
1220B-600	316L stainless	316L stainless	25mm	3	15ml	600mm
1220B-900	316L stainless	316L stainless	25mm	3	20ml	900mm
1220B-1500	316L stainless	316L stainless	25mm	5	20ml	1500mm
1220J-900	316L stainless	316L stainless	40mm	3	90ml	900mm
1220J-1500	316L stainless	316L stainless	40mm	4	90ml	1500mm
1220J-2000	316L stainless	316L stainless	40mm	4	90ml	2000mm

Accessories	
8005A-01	Sealing Sleeve Set - Covers pockets - set of 3 sleeves (25mm diameter - suitable for 1220A and 1220B)
8005A-02	Sealing Sleeve Set - Covers pockets - set of 3 sleeves (40mm diameter - suitable for 1220J)
1220X-600	Emptying rack for 600mm sampler (25mm diameter - suitable for 1220A and 1220B)
1220X-900	Emptying rack for 900mm sampler (25mm diameter - suitable for 1220A and 1220B)
1220X-1500	Emptying rack for 1500mm sampler (25mm diameter - suitable for 1220A and 1220B)
1220Y-900	Emptying rack for 900mm sampler (40mm diameter - suitable for 1220J)
1220Y-1500	Emptying rack for 1500mm sampler (40mm diameter - suitable for 1220J)
1220Y-2000	Emptying rack for 2000mm sampler (40mm diameter - suitable for 1220J)
LUG-1	Earthing connection point. See page 166

Additional Tips	See page 56 (for rounded or very pointed tips)
Cleaning brushes	See page 184
Storage Cases	See pages 186-187
XRF	Material certification verified by XRF (See page 196)

AccuPod®
Minimise Sampling Error



The AccuPod® is the next generation in sampling technology. It combines a single use disposable Pod with a reusable stainless steel sample thief.

The AccuPod® is designed to minimise sampling error which can occur when a sample is transferred from one container to another. With the AccuPod® the sample remains in the pod until it is needed in the laboratory.

The AccuPod® is ideal for sampling free flowing powders and granules.



Coming soon please contact us for availability

The AccuPod® is simple to use.

- Insert the Pods into the sample thief
- Take sample
- After sampling click the lids onto the Pods
- Take the Pods to the laboratory
- Slide off the lid to access the sample



On Line Video

To find out more about the AccuPod® please visit

www.sampling.com/product_channel



It's as easy as 1, 2, 3

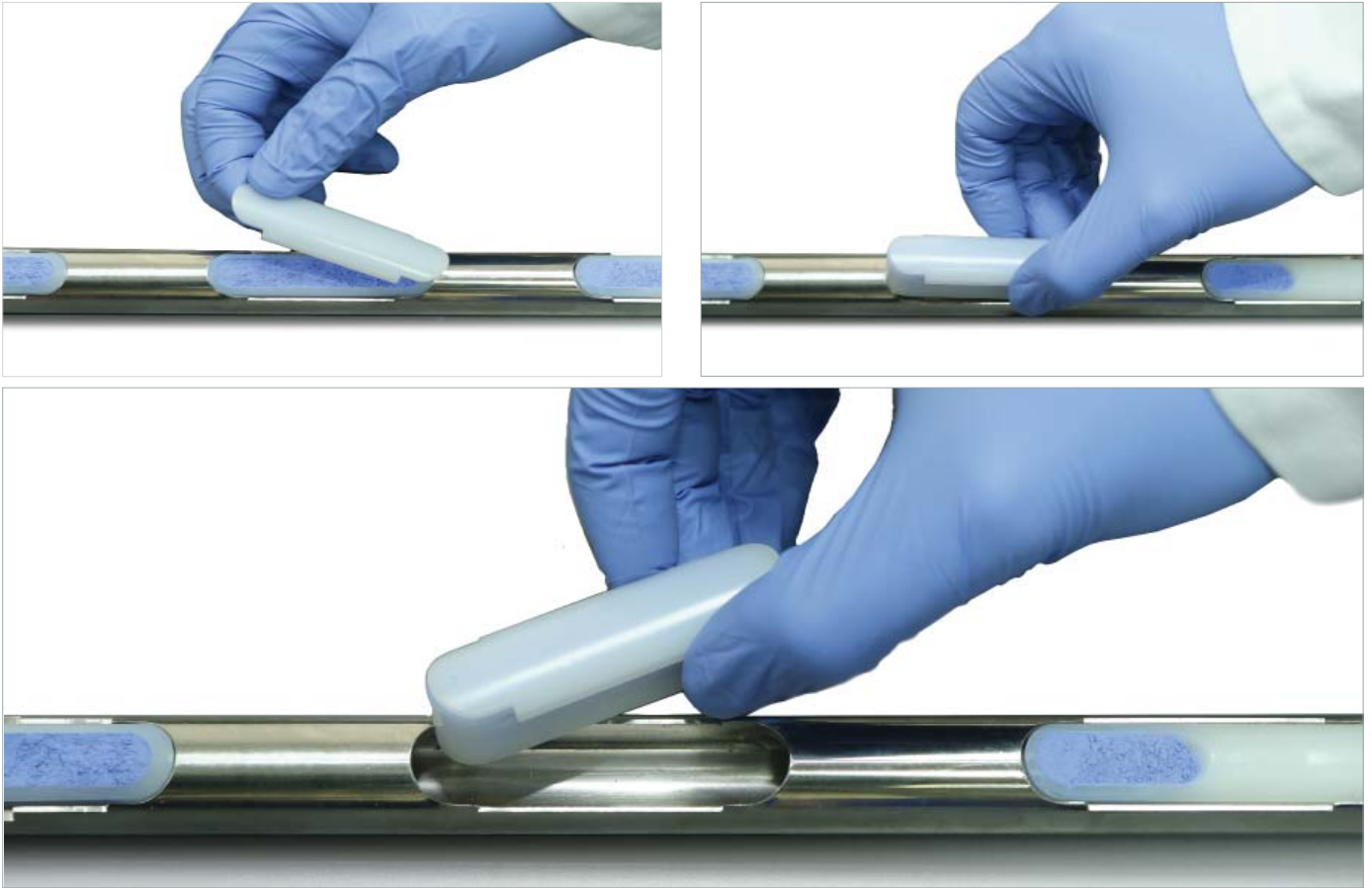

Pods

- Made from FDA, EU and EC compliant HDPE
- Initially available in 1ml and 5ml sizes. Other sizes to follow - please contact us for details
- Supplied with lid (lid supplied loose in the bag)
- Individually bagged
- Made in a Class 8 (class 100,000) cleanroom
- Available pre sterilised (gamma irradiation)



Part No.	Nominal Volume	Sterile	Material	Pack Size
8360T-10	1ml	No	HDPE	50
8360T-10S	1ml	Yes	HDPE	50
8360T-50	5ml	No	HDPE	50
8360T-50S	5ml	Yes	HDPE	50

AccuPod® Sample Thief

- Made from 316L stainless steel
- Available in a range of different lengths
- Available from stock
- 25mm Diameter
- Samplers with a bespoke number of ports available on request

Single Port

Part No.	Sampler Length	No. of Ports
1360A-601	600mm	1
1360A-1001	1000mm	1
1360A-1501	1500mm	1
1360A-2001	2000mm	1

Multi Port

Part No.	Sampler Length	No. of Ports
1360A-603	600mm	3
1360A-1003	1000mm	3
1360A-1503	1500mm	3
1360A-2003	2000mm	3



Unit Dose Sample Thief

Unit Dose Sampling made easy

The Unit Dose Sample Thief is a highly versatile sampler for taking multiple samples at multiple heights within the product.

The operator can quickly change the sample volume and the number of samples taken by simply changing the inner rod.

- Multilevel Unit Dose Sampling
- Ideal for sampling free flowing powders and granules
- Take one, two or three samples at each sampling height
- 316L stainless steel



Above - Triple Style Sampler

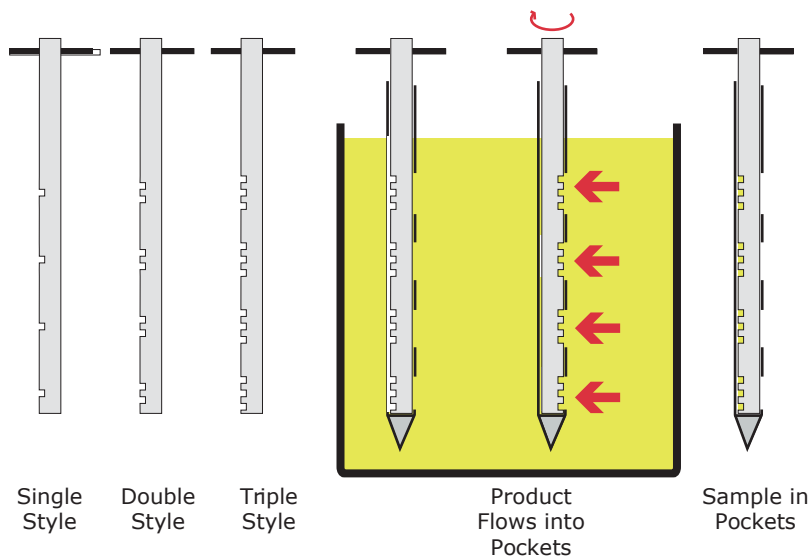

Operation:

1. Select the correct Inner Rod and fit it inside the Outer Tube
2. Insert the sampler into the product, turn the handle to expose the pockets to the product.
3. Turn the handle to the original closed position, then remove the sampler from the product.
4. Remove the Inner Rod from the Outer Tube to expose the samples.

Note:

Maximum sample volume is 3ml per pocket

Ordering -

This sampler is made to order.

To place an order let us know:

- Length of sampler
- Number of sampling positions
- Number of samples to be taken at each sampling position (Do you require a Single, Double or Triple style sampler?)
- Volume of each sample

Please contact us to discuss your requirements.

Sample Containers

For a complete range of sample bottles and containers please see pages 135-151.



Powder Trier

High Quality Trier - ideal for powders, granules & grains

The Sampling Systems Powder Trier is ideal for taking a large volume, cross sectional sample from a container. The sampler has a robust all stainless steel construction and is suitable for sampling cereals, grains, free flowing powders, granules and even slightly cohesive powders

- Cross section (composite sample)
- 316L stainless steel, bright finish
- Suitable for taking a large volume sample from compacted powders, grains etc.



Powders Multi Level Sampling

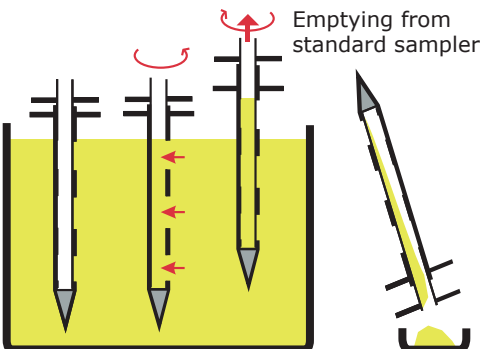

Emptying from standard sampler

Operation

1. Insert the sampler into the product
2. Turn the handle to open the slot - the product can now be collected in the central tube
3. Turn the handle to close the slot
4. Remove the sampler
5. Invert the sampler to discharge the sample

Note: The cutting scroll is not shown in the sketches



Part No.	Sampler Length	Number of Slots	Sampler Diameter	Maximum Sample volume	Material
1216A-600	600mm	3	25mm (excluding scroll)	110ml	316L ss
1216A-1000	1000mm	4	25mm (excluding scroll)	190ml	316L ss
1216A-1500	1500mm	5	25mm (excluding scroll)	300ml	316L ss

Additional Tips	See page 56 (for rounded or very pointed tips)
Cleaning brushes	See page 184
Storage Cases	See pages 186-187
XRF Certification	See page 196

U-D Master

Unit Dose Sampling to meet FDA Guidelines

The patented U-D Master is designed for multilevel low volume sampling in the pharmaceutical industry. It is ideal for use with free flowing powders. By simply changing the sample inserts (cells) different volumes can be sampled. The sampler is available in two convenient diameters 22mm (Standard U-D Master) and 13mm (Micro U-D Master - please contact us for info).

- Manufactured from 316L stainless steel
- Satin polish (Ra < 1microns)
- Take Multiple Samples from the same Point
- Range of sampler lengths
- Change the sample volume by changing the insert
- Special finishes and materials of construction available on request



Sample Inserts are available in a range of sizes from 0.1ml to 4.0ml, plus blank inserts



More than one sample can be taken from the same sampling point (see double or triple styles).



Single style sampler

Double style sampler

SINGLE Style Sampler

Collects ONE set of samples at each sampling point.

DOUBLE Style Sampler

Collects TWO sets of samples at each sampling point.

TRIPLE Style Sampler

Collects THREE sets of samples at each sampling point.

Operation:

1. Select the correct volume Inserts and fit them into the Inner Rod.
2. Slide the assembled Inner Rod into the Outer Sleeve at the lowest sampling level
3. Insert the sampler into the product, turn the handle to expose the sampling cells to the product.
4. Double and Triple Style samplers - pull the handle to the next level to expose the next set of sampling cells.
5. Turn the handle so no Sampling Inserts are exposed then remove the sampler from the product.
6. Remove the Inner Rod from the Outer Sleeve, the individual Sampling Inserts can then be easily removed for analysis.

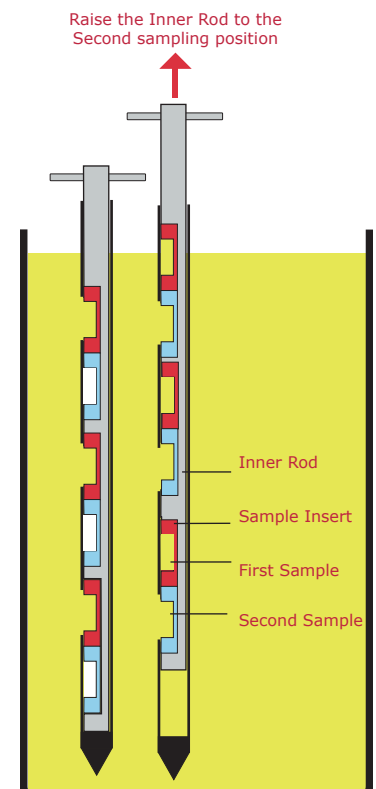

Drawing showing how the Double Style Sampler takes two samples from each sampling point.

U-D Master

Cont.....

Sample Inserts are stamped with their volume for easy identification

Choose the right inserts to get the required sample volume



	Part No.	Sampler Length	Sampler Diameter	Number of Sampling Points	No. of Sampling Cells needed
SINGLE Style Sampler	1230A-300	300mm	22mm	5	5
	1230A-600	600mm	22mm	10	10
	1230A-900	900mm	22mm	6	6
	1230A-1200	1200mm	22mm	8	8
	1230A-1500	1500mm	22mm	10	10
	1230A-1800	1800mm	22mm	12	12
DOUBLE Style Sampler	1230B-600	600mm	22mm	5	10
	1230B-900	900mm	22mm	7	14
	1230B-1200	1200mm	22mm	8	16
	1230B-1500	1500mm	22mm	10	20
	1230B-1800	1800mm	22mm	12	24
TRIPLE Style Sampler	1230C-900	900mm	22mm	5	15
	1230C-1200	1200mm	22mm	7	21
	1230C-1500	1500mm	22mm	8	24
	1230C-1800	1800mm	22mm	10	30

Sample Inserts

Sample Inserts are available in 0.1ml increments from 0ml to 4ml.
 Part Number is 1230T-XX (where XX = Cell Volume)
 For Example - The Part Numbers for 1.2ml and 0.5ml Inserts are : 1230T-12 and 1230T-05 respectively
 1230T-00 = Blank Insert

Accessories		
	Cleaning Brushes	See page 184
	Storage Case	See pages 186-187
	XRF certification	See page 196

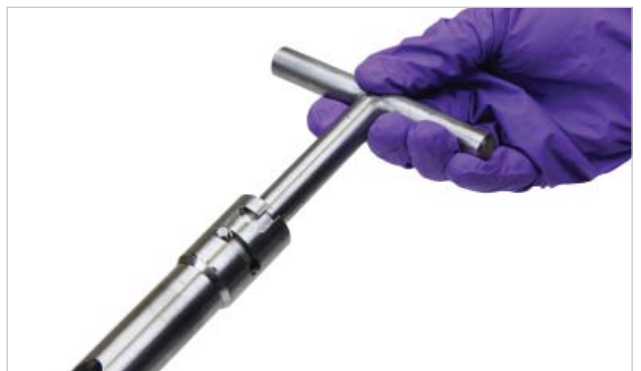

UD Tablet Maker

After Sampling make a Tablet to reduce Sampling Error

The U-D Tablet Maker is designed to compress the powder samples taken by the U-D Master. By compressing the sample it ensures that loose powder is not lost during handling, this helps to reduce sampling error.

Special Split Sample Cells need to be used in place of the standard sample cells. (Note: These inserts will only work with the standard U-D Master)

What Do I Need?

1. The U-D Tablet machine (see table below)
2. Special split samples cells (see table below)
3. The correct tablet punches for the split sample cells (see table below)
4. Sampler - see Standard U-D Master (see pages 78-79)



Split Sample Inserts



Part No.	Description
1230TABLET	Tablet Compression Machine - manually operated - Size - 200mm x 400mm x 400mm high

Split Sample Inserts are available in 0.1ml increments from 0 to 3ml.
 Part no. is 1230T-XXS (where XX= cell volume)
 For example - The part number for 1.2ml and 0.5ml respectively are: 1230T-12S and 1230T-05S

1230P-01	Punch for use with 0.1ml split Sample Inserts
1230P-02	Punch for use with 0.2ml split Sample Inserts
1230P-03	Punch for use with 0.3, 0.4, 0.5 and 0.6ml split Sample Inserts
1230P-07	Punch for use with 0.7, 0.8, 0.9, 1.0 and 1.1ml split Sample Inserts
1230P-12	Punch for use with 1.2, 1.3, 1.4, 1.5, 1.6, 1.7, 1.8, 1.9 and 2.0ml split Sample Inserts
1230P-21	Punch for use with 2.1, 2.2, 2.3, 2.4, 2.5, 2.6, 2.7, 2.8, 2.9 and 3ml split Sample Inserts



Over 1 Million Stock Items

At our state of the art warehouse we keep over 1 million items in stock. Stock is controlled by the latest software so we can ship 95% of orders on the day the order is placed.

Maxi Corer

The Maxi Corer is suitable for the surface sampling of powders and granules. It can also take core samples.

- 316L stainless steel construction
- Two sizes
- Crevice free
- Satin finish



Part No.	Diameter	Overall Length	Scoop Length	Material
7010A-01	25mm	300mm	200mm	316L ss
7010A-02	25mm	600mm	500mm	316L ss

XRF Certification - See page 196

V Spatula

Multi Purpose Spatula

The V Spatula from Sampling Systems is ideal for surface sampling of powders and core sampling of viscous material like cheese, pastes and gels.

The 'V' shape allows easy discharge of the powders into containers or bags.

- 316L stainless steel
- Polished finish
- Fully welded, crevice free construction



Part No.	Blade Width	Overall Length	Blade Length	Material
1095N-150	20mm	233mm	150mm	316L ss
1095N-250	20mm	333mm	250mm	316L ss
1095S-150	33mm	230mm	145mm	316L ss

XRF Certification - See page 196



Powder Lance

Cross Sectional Sampler for Cohesive Powders

The Powder Lance can be used to take large volume samples of cohesive powders. The sampler can be used horizontally through a sack or it can be used vertically.

The sampler has a built in scraper to push the powder into the sampler.

- Cross sectional sampler
- Made from 316L stainless steel
- Suitable for sticky cohesive powders

Operation:

1. Insert the sampler into the product.
2. Rotate the sampler through 360°. The scraper forces the powder in to the sampler along the length of the slot.
3. Remove the sampler.
4. Unscrew the tip of the sampler.
5. Push the Sample Ejection Rod into the Powder Lance to push out the sample

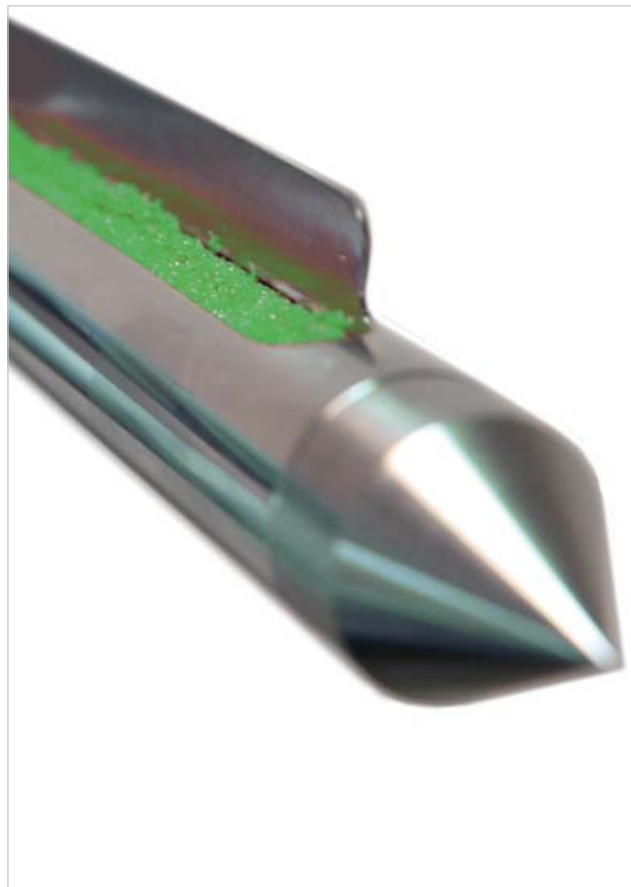

Part No.	Overall Sampler Length	Length of Sampling Slot	Max Sample Volume	Material
2250A-600	630mm	540mm	190ml	316L ss
2250A-1000	1030mm	930mm	300ml	316L ss
2250A-2000	2030mm	1500mm	520ml	316L ss
8570A-700	Sample Ejection Rod - 700mm length			316L ss
8570A-1100	Sample Ejection Rod - 1100mm length			316L ss

Cleaning Brushes - See page 184

Sampler Cases - See pages 186-187

XRF Certification - See page 196

Cohesive Sampler

Single Point Sampler for Cohesive Powders

The Cohesive Sampler is able to take a sample from a known point within the product.

- Single Point Sampler
- 316L stainless steel
- Suitable for sticky, cohesive powders

Operation

1. Insert sampler into product ensuring that the sample collecting chamber is in the closed position
2. At the correct sampling depth, turn the inner tube to expose the sample collecting chamber
3. Rotate the entire sampler through 360°. The scraper collects product and guides it into the sample collecting chamber.
4. Turn the inner tube to close the sample collecting chamber
5. Remove sampler
6. Pull out the inner tube and discharge the sample

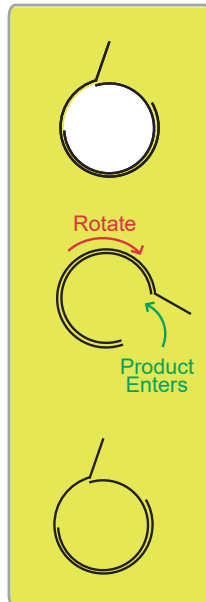

Part No.	Sample Volume	Sampler Length	Sampler Diameter	Material
2015A-05	5ml	1000mm	25mm	316L ss
2015A-10	10ml	1000mm	25mm	316L ss
2015A-25	25ml	1000mm	25mm	316L ss

Additional Tips - see page 56 (for rounded or very pointed tips)

Cleaning Brushes - See page 184

Sampler Cases - See pages 186-187

XRF Certification - See page 196

Cohesive Pocket Sampler

Zone sampling of Cohesive powders

The Cohesive Pocket Sampler has been specially adapted from the Pocket Sampler (on pages 72-73) to enable the taking of samples from damp and cohesive powders.

Scrapers have been added to push the sticky powder into the sample pockets. Scrapers are fully welded to give a hygienic, GMP correct sampler.

- Multilevel (discrete samples)
- 316L Stainless steel construction
- Suitable for sticky, cohesive powders

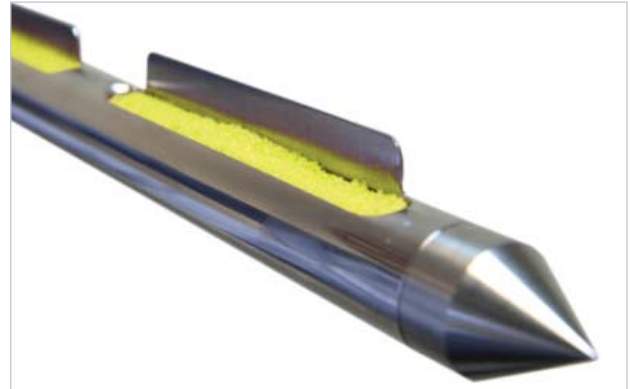

2220B-900

Operation

1. Insert the sampler into the product
2. At the required depth rotate handle to expose the collecting pockets.
3. Rotate the sampler through 360° so the product is pushed into the collecting pockets
4. Rotate handle to close pockets and remove sampler.

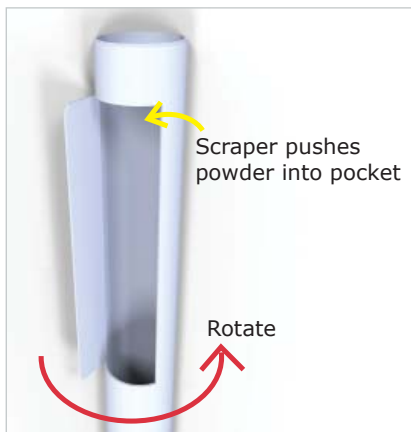

Part No.	Sampler Length	Number of Pockets	Nominal Volume of each Pocket	Diameter*	Material
2220B-600	600mm	3	15ml	25mm	316L ss
2220B-900	900mm	3	20ml	25mm	316L ss
2220B-1500	1500mm	5	20ml	25mm	316L ss

Additional Tips - see page 56 (for rounded or very pointed tips)

Cleaning Brushes - See page 184

Sampler Cases - See pages 186-187

XRF Certification - See page 196

* Diameter does not include scrapers. Scrapers are approximately 10mm high

Cohesive Slot Sampler

Composite sampling of Cohesive powders

The Cohesive Slot Sampler has been specially adapted from the popular Slot Sampler (on pages 70-71). Scrapers have been added to push the non flowing powder into the sample slots.

Scrapers are fully welded to give a hygienic, GMP correct sampler.

- Multilevel (composite samples)
- 316L Stainless steel construction
- Suitable for sticky, cohesive powders



Part No.	Sampler Length	Number of Sampling Slots	Maximum Sample Volume	Diameter*	Material
2210A-600	600mm	3	110ml	25mm	316L ss
2210A-1000	1000mm	4	190ml	25mm	316L ss
2210A-1500	1500mm	5	300ml	25mm	316L ss

Additional Tips - see page 56 (for rounded or very pointed tips)

Cleaning Brushes - See page 184

Sampler Cases - See pages 186-187

XRF Certification - See page 196

* Diameter does not include scrapers. Scrapers are approximately 10mm high

FreeGlide®

The only In-Line Powder Sampler guaranteed not to jam

Patented

The FreeGlide is a patented in-line powder sampler. It is designed to be installed in a vertical pipe and to take samples as the powder fall down pipe. The FreeGlide has a number of innovative features that make it ideal for use in the food and pharmaceutical industries.

FreeGlide Features

- The sample is collected in a cup and so is not physically altered by the sampling process
- In between taking samples the full bore of the pipe is available for product flow
- The product contact parts are either 316L stainless steel or FDA acceptable polymers
- Available with manual or automated operation
- Available in a range of standard sizes
- Quickly dismantles for cleaning between batches



Powders



FreeGlide® samplers are available to suit different pipe diameters and can be either manually or pneumatically operated

Diaphragms

At the heart of the FreeGlide is our patented diaphragm. The diaphragm is made from a flexible polymer and it separates the product area from mechanical area. The diaphragm ensures that powder and dust does not enter the bearings and this keeps the sampler from jamming during use.

Diaphragms are available in three FDA acceptable polymers (silicone, Viton and EPDM).



Silicone (Blue)
Silicone (White)
EPDM (Black)
Viton (Green)

The FreeGlide® is the easy way to take samples from free-falling powders in downpipes

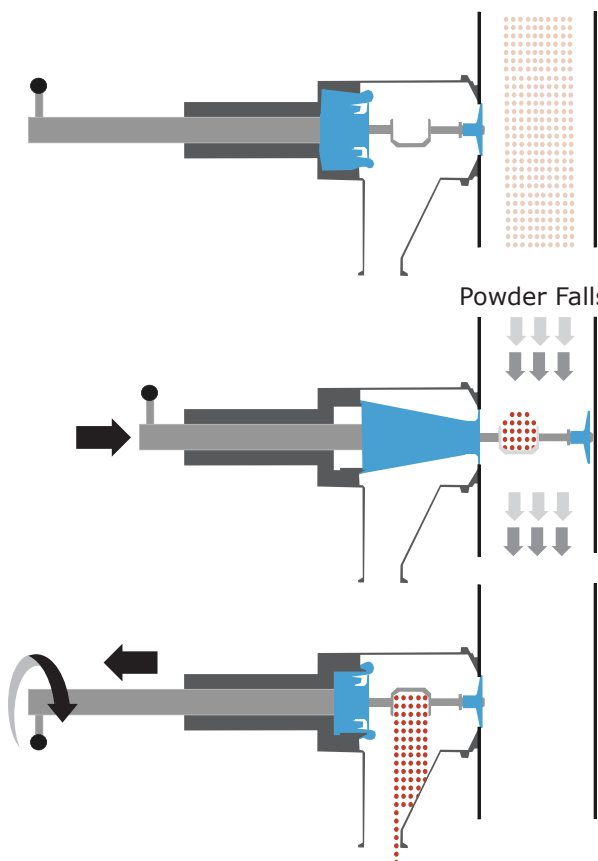
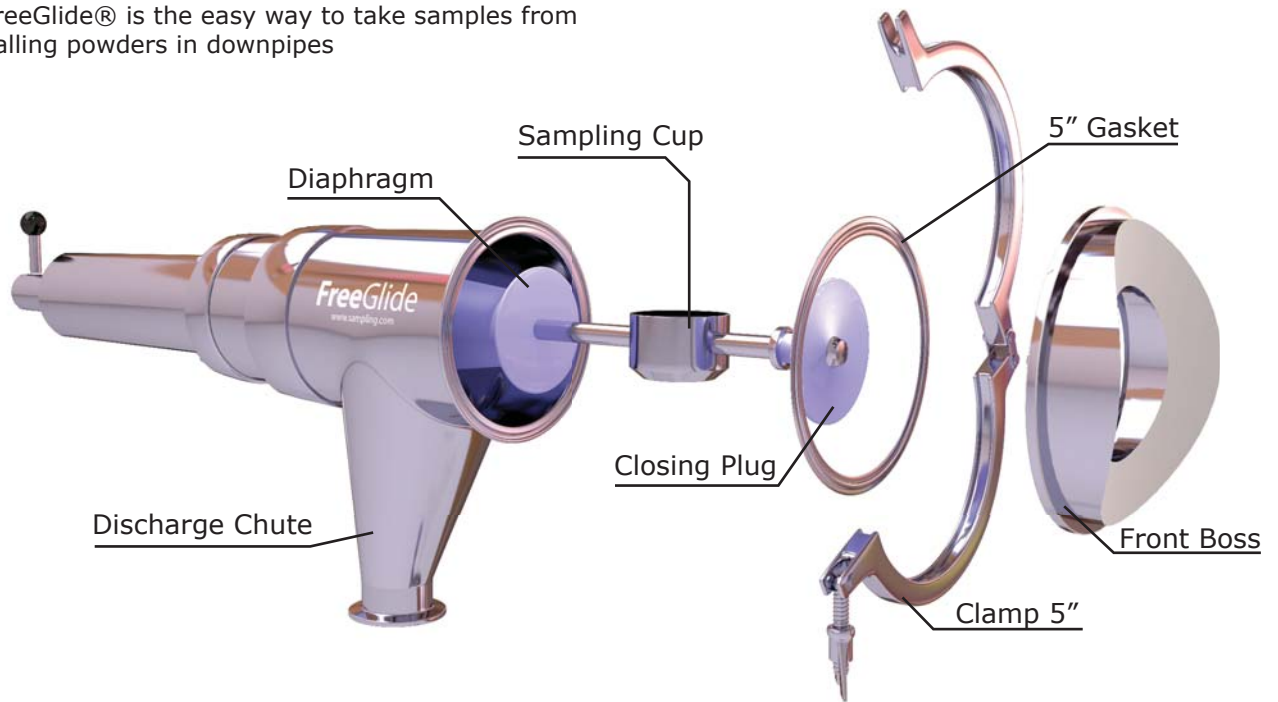

Operation

Resting

When the FreeGlide is not in use the full bore of the downpipe is available for powder flow.

Sampling

The sampling cup is extended into the downpipe to catch the product as it falls.

Discharging

The sampling cup is then retracted and inverted. The powder sample falls down the discharge chute to where it is collected

Materials of Construction

- | | |
|--------------------|---|
| Contact parts: | <ul style="list-style-type: none"> • 316L stainless steel • Silicone rubber, Viton or EPDM |
| Non contact parts: | <ul style="list-style-type: none"> • 304 grade stainless steel • Other materials as required. |
| Operation: | <ul style="list-style-type: none"> • Manual or Pneumatic actuation |



On Line Video

To see how easy it is to use the FreeGlide please visit

www.sampling.com/product_channel

Download the full brochure at: www.sampling.com/download.html

Sample Lance



The Sample Lance is ideal for taking cross sectional samples of powders and some pastes. It is manufactured from high quality 316L stainless steel.

The Sample Lance is available with a range of different handles. The Heavy Duty Handles is ideal when the powder is hard and dense. They give additional leverage when the sampler is pushed into the product. Sample Lances can be supplied without handles when the powder is light and fluffy. Heavy Duty handles are suitable for all other applications.

Operation is simple. Just push the sampler into the powder to take a core sample.

- Manufactured in 316L stainless steel
- Available in different sizes and handle combinations
- Can be used for sampling in production, goods in and general applications
- Available from stock

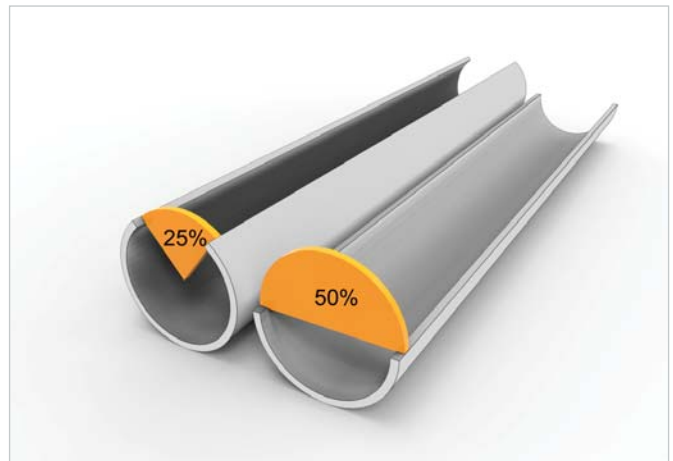

Part No.	Length	Lance Opening Size	Handle Type	Width	Material
1660P-600	600mm	25%	Plain	25mm	316L ss
1660P-1000	1000mm	25%	Plain	25mm	316L ss
1665P-600	600mm	50%	Plain	25mm	316L ss
1665P-1000	1000mm	50%	Plain	25mm	316L ss
1660H-600	600mm	25%	Heavy Duty	25mm	316L ss
1660H-1000	1000mm	25%	Heavy Duty	25mm	316L ss
1665H-600	600mm	50%	Heavy Duty	25mm	316L ss
1665H-1000	1000mm	50%	Heavy Duty	25mm	316L ss

Liquid Samplers



Liquid Master

Ideal for Sampling Various Liquids



The Liquid Master is ideal for taking samples from low and medium viscosity liquids. It is available in a range of lengths and diameters to give a range of sample volumes.

The Liquid Master is easy to use and is designed to be quickly stripped down for cleaning.



Type: Single Point & Cross Sectional Sampling

Materials: 316L stainless steel, Food grade PTFE or standard PP

Operation:

Technique 1 - Point Sampling

Insert the sampler. Press the push button to take the sample. Remove the sampler.

Technique 2 - Cross Sectional

Press the Push Button and then slowly insert the sampler into the product. As the sampler is pushed in a cross sectional sample is taken. Release the push button at the required depth to stop any more liquid from entering the Sampler. Remove the sampler.

NB. To take a large sample the sampler needs to be inserted deep into the product.

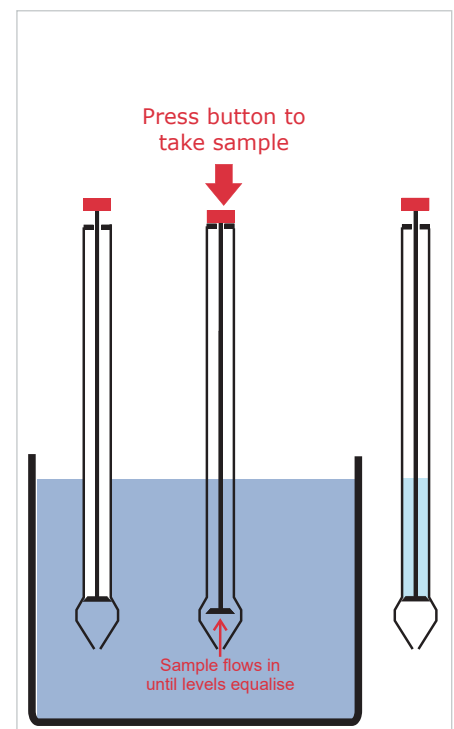



Sampler Tip
Seal arrangement prevents
sample from dripping



Push Button to open the
valve in the tip and take
the sample



Quick & easy to use



Part No.	Product Contact Material	Length	Maximum Sample Volume	Diameter
5035J-1000	PTFE/FEP	1000mm	500ml*	35mm
5035J-1500	PTFE/FEP	1500mm	1000ml*	35mm
5035J-2000	PTFE/FEP	2000mm	1500ml*	35mm
5035S-600	316L stainless steel & silicone O-ring	600mm	150ml**	25mm
5035S-1000	316L stainless steel & silicone O-ring	1000mm	270ml**	25mm
5035S-1500	316L stainless steel & silicone O-ring	1500mm	420ml**	25mm
5035S-2000	316L stainless steel & silicone O-ring	2000mm	500ml**	25mm
5035T-601	PTFE/FEP	600mm	150ml**	25mm
5035T-1001	PTFE/FEP	1000mm	270ml**	25mm
5035T-1501	PTFE/FEP	1500mm	390ml**	25mm
5035T-2001	PTFE/FEP	2000mm	510ml**	25mm
5035T-2501	PTFE/FEP	2500mm	660ml**	25mm
5035P-600	Polypropylene	600mm	150ml**	25mm
5035P-1000	Polypropylene	1000mm	270ml**	25mm
5035P-2000	Polypropylene	2000mm	420ml**	25mm

Cleaning Brushes - See page 184

Storage Cases - See page 186

XRF Certification - See page 196

*A 5ml sample will be taken for every 10mm the Liquid Master is inserted into the product

**A 3ml sample will be taken for every 10mm the Liquid Master is inserted into the product

Pump Sampler

Highly effective hand operated sample pump

Pump Samplers allow the liquids to be simply and quickly sampled. The chance of cross contamination is greatly reduced by using new dip-tube and bottles for each sample.

- Suitable for use with low to medium viscosity liquids.
- Single Point Sampler
- PE, PTFE or 316L stainless steel product contact parts

Operation:

1. Cut the sampling tube to the required length or use the pre cut sterile tube.
2. Screw the collecting bottle to the base of the hand pump.
3. Insert one end of the sampling tube through the hand pump and into the collecting bottle.
4. Drop the other end of the sampling tube into the product. At the required depth pump the handle. Several pumps will fill the sample collecting bottle.

Pump Efficiency

The Pump Sampler is highly efficient and is able to pump water to a height of about 4m



The pump is not a product contact part. Only the tube and collecting bottle come into contact with the product

PTFE Sampler Set

Part No. 5020T-01

Set Includes

- 1 off plastic hand pump with PTFE bottle adapter
- 1 off PFA Bottle (180ml)
- 1 off Sampling Tube - PTFE - 5m
- 1 off Tube cutter
- 1 off Stainless steel hose weight
- 1 off Carrying case



Part No.	Description
5020T-01	PTFE Pump Sampler Set
Spares:	
5020A-09	Hand Pump - Plastic
5020A-11	Adapter for pump and PFA sample bottles (type 5020A-03 and 5020A-04)
5020T-05	Sampling Tube - PTFE - 5m
5020T-100	Sampling Tube - PTFE - 100m
5020T-100USP	USP Class VI Sampling Tube - PTFE - 100m with cert
5020A-07	Tube cutter
Bottles:	
5020A-03	Sample bottle - PFA - 90ml
5020A-04	Sample bottle - PFA - 180ml

Use Your Existing Sample Collection Bottles

If you wish to use your own sample bottles then PTFE adapters are available for a wide variety of standard bottle neck sizes. However, if your bottle has an unusual thread we can make you a special PTFE adapter.

When ordering an adapter please post us one of your bottles.

We keep bottle adapters for GL45 threads in stock.



Part No.	Description
5020X-45P	Bottle adapter for bottles with GL45 thread. Suitable for the plastic pumps.
5020X-1	Special bottle adapter for plastic pump. Up to 50mm neck size
5020X-2	Special bottle adapter for plastic pump. Up to 100mm neck size
5020X-3	Special bottle adapter for plastic pump. Neck diameter larger than 100mm

PE Sampler Set

Part No. 5020P-01



Set Includes:

- 1 off plastic hand pump with PE bottle adapter
- 10 off PE Bottles (100ml)
- 1 off Sampling Tube - PE - 10m
- 1 off Tube cutter
- 1 off Stainless steel hose weight
- 1 off Carrying case



Part No.	Description
5020P-01	PE Pump Sampler Set (see above for contents)
Spares:	
5020A-09	Hand Pump Plastic (without adapter)
5020A-10	Adapter for pump and PE sample bottles (type 8130A)
5020P-100	Sampling Tube - PE - 100m with general cert
5020P-101	Sampling Tube - PE - 100m with batch cert
5020A-07	Tube cutter
Bottles:	
8130A-100	Sample bottle - PE - 100ml
8130A-250	Sample bottle - PE - 250ml
8130A-500	Sample bottle - PE - 500ml
8130A-1000	Sample bottle - PE - 1000ml

Stainless Steel Sampler Set

Part No. 5020S-02



Set Includes:

- 1 off stainless steel hand pump and stainless steel bottle adapter
- 10 off PE Bottles (100ml)
- 1 off Sampling Tube - PE - 10m
- 1 off Tube cutter
- 1 off Stainless steel hose weight
- 1 off Carrying case



Part No.	Description
5020S-02	Stainless Steel Pump Sampler Set
Spares:	
5020S-01	Hand Pump Stainless Steel
5020P-100	Sampling Tube - PE - 100m
5020T-100	Sampling Tube - PTFE - 100m
5020A-07	Tube cutter
Bottles:	
8130A-100	Sample bottle - PE - 100ml
8130A-250	Sample bottle - PE - 250ml
8130A-500	Sample bottle - PE - 500ml
8130A-1000	Sample bottle - PE - 1000ml

Pre-cut & Pre-sterilised Tube



Individually bagged LDPE tube ready to use straight from the bag.

- Made from LDPE which conforms to FDA, EC 1935/2004 & EU 10/2011
- Individually bagged
- External Diameter is 8mm, Internal Diameter is 6mm
- Available sterile

Part No.	Tube Length	Sterile	Qty Per Box
5020L-01	1m	No	100
5020L-01S	1m	Yes	100
5020L-02	2m	No	20
5020L-02S	2m	Yes	20
5020L-04	4m	No	15
5020L-04S	4m	Yes	15

TeleScoop

The Extendable Sampler For Liquid Sampling



The TeleScoop is suitable for taking samples from liquids and suspensions.

A range of light weight, aluminium telescopic handles is available which makes this the ideal sampler to use when sampling from places such as: overhead gantries, river banks, water outlets etc.

The attachments are all interchangeable with the telescopic rods.

Attachments for telescopic rods



Angular Beaker 5065B

The beaker can be easily adjusted to the required angle



Pendulum Beaker 5065C

Always swings to the upright position



Surface Net 5065M

310 x 280mm
Mesh size 2 to 5mm



Stainless Beaker

5065B-1000B

Sampling beaker made from hygienic 304 stainless steel



Bottle Holder 5065D

Suitable for bottles up to 95mm diameter. Price includes one 750ml LDPE bottle



Deep Catch Net 5065N

190 x 430mm
Mesh size 2 to 5mm



Multi Purpose

The heads can be quickly interchanged by our simple clip system.



Telescopic Rods

Easily adjustable to the required length.
Robust, light weight aluminium or stainless steel construction.



TeleScoop Rods



Part No.	Description	Length	Material
5065A-1200	Telescopic Rod	720 to 1200mm	Aluminium & plastic
5065A-2500	Telescopic Rod	1320 to 2500mm	Aluminium & plastic
5065A-2800	Telescopic Rod	1020 to 2800mm	Aluminium & plastic
5065A-3000	Telescopic Rod	1230 to 3000mm	Aluminium & plastic
5065A-4500	Telescopic Rod	1720 to 4500mm	Aluminium & plastic
5065A-6000	Telescopic Rod	1820 to 6000mm	Aluminium & plastic
5065S-1500	Telescopic Rod	800 to 1500mm	316L stainless steel & PTFE
5065S-3000	Telescopic Rod	1500 to 3000mm	316L stainless steel & PTFE
5065S-4500	Telescopic Rod	1500 to 4500mm	316L stainless steel & PTFE

TeleScoop Attachments & Spares



Part No.	Description	Volume	Material
5065B-600	Angular Beaker	600ml	Polypropylene
5065B-1000	Angular Beaker	1000ml	Polypropylene
5065B-2000	Angular Beaker	2000ml	Polypropylene
5065B-1000B	Angular Beaker	1000ml	304 Stainless Steel
5065C-600	Pendulum Beaker	600ml	Polypropylene
5065C-1000	Pendulum Beaker	1000ml	Polypropylene
5065C-2000	Pendulum Beaker	2000ml	Polypropylene
5065C-1000B	Pendulum Beaker	1000ml	304 Stainless Steel
5065D-750	Bottle Holder	750ml	Polypropylene & Aluminium, LDPE bottle
8125A-750	Spare Bottle	750ml	LDPE
5065M-310	Surface Catch Net	310 x 280mm	Polypropylene & Polyamide
5065N-190	Deep Catch Net	190 x 430mm	Polypropylene & Polyamide

Bottle Sampler

Takes Samples Straight into the bottle

The Bottle Sampler takes samples straight into the bottle. The spring loaded mechanism means that liquid only flows in when the handle is squeezed allowing samples to be taken from set locations.

- Low to medium viscosity liquids.
- Single Point liquid sampling
- Sampler body - 316L stainless steel, Bottle - glass

Ideal for taking quick samples direct into the bottle. The sampler is available with a cover that goes over the bottle to stop the bottle from getting wet.



Sampler with protective cover that also helps to keep the bottle dry during sampling

Bottle Sampler with protective Bottle Cover



Bottle Sampler without Bottle Cover

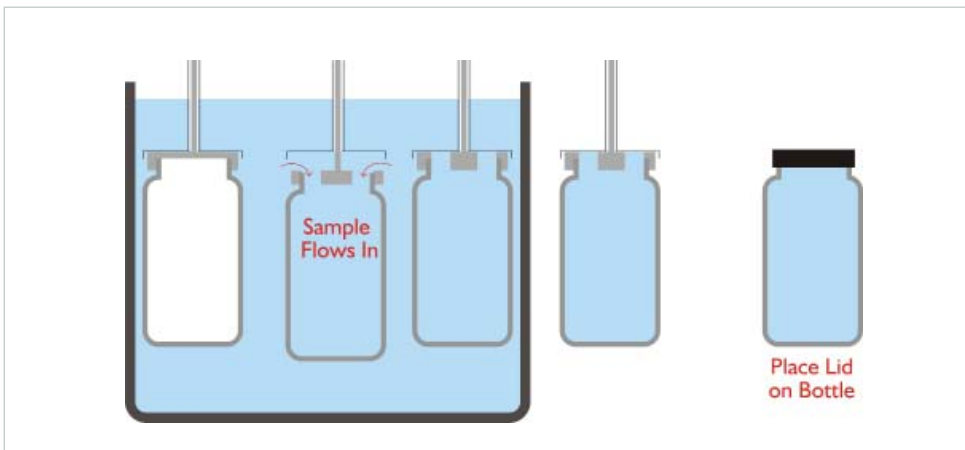

Part No.	Overall Length	Bottle Cover	Bottle Size
5031S-1000	1000mm	No	500ml
5031C-1000	1000mm	Yes	500ml
5031S-1500	1500mm	No	500ml
5031C-1500	1500mm	Yes	500ml

Accessories

8020N-1100	Narrow cleaning brush - 1100mm
8020N-1600	Narrow cleaning brush - 1600mm
5031B-500	Spare 500ml Bottle
XRF Certification	See page 196

Cup Sampler

Suitable for high and low viscosity liquids and suspensions

The ever popular Cup Sampler is ideal for sampling liquids and suspensions. The device is manufactured from 316 stainless steel. The Cup Sampler enables discrete samples to be easily taken from known heights within the product.

- Single Point Liquid Sampler
- 316L stainless steel product contact parts

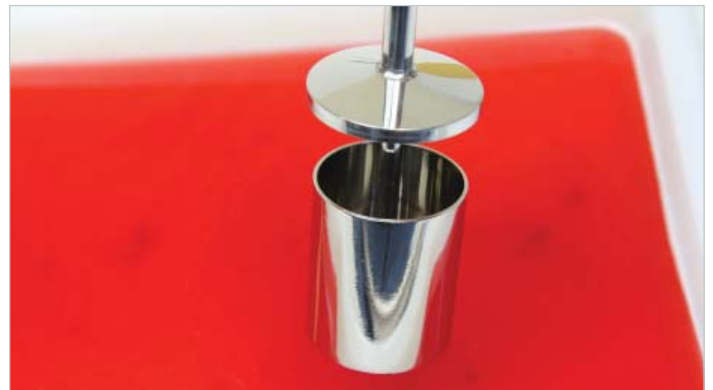

Operation

1. Insert the sampler to the required depth.
2. Squeeze handle which pushes the cup away from the lid, allowing the liquid to enter the cup.
3. After filling remove the sampler. To empty the sampler either tip the sampler whilst squeezing the handle or unscrew the collecting cup.

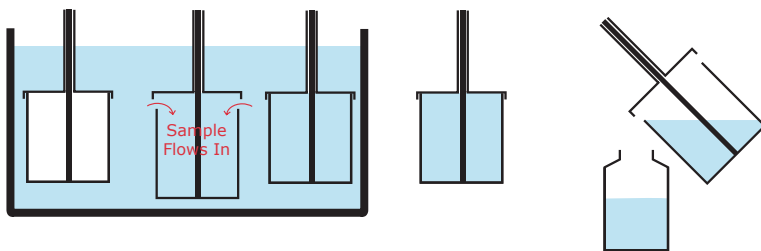

5030A-600



Part No.	Overall Length	Nominal Cup Volume	Max. Diameter of Cup
5030A-600	600mm	100ml	55mm
5030A-1000	1000mm	100ml	55mm
5030A-1500	1500mm	100ml	55mm
5030J-1000	1000mm	500ml	80mm
5030J-1500	1500mm	500ml	80mm

Accessories	
8020N-1100	Narrow Cleaning Brush - 1100mm
8020N-1600	Narrow Cleaning Brush - 1600mm
Storage Cases	See pages 186-187
XRF Certification	See page 196

Fluid Point Sampler

Take liquid samples from a known point



The Fluid Sampler is ideal for sampling pharmaceuticals, cosmetics and food stuffs. The design allows rapid point sampling from drums, kegs and most containers. To take a sample simply insert the sampler into your liquid and then pull the handle to take the sample. After sampling push down the handle to eject the sample.

- Manufactured in 316L stainless steel with a silicone seal (FDA grade)
- Available in different lengths
- Easy to clean
- Available from stock for fast delivery worldwide



Part No.	Length	Diameter	Max. Sample Volume	Material
5551S-600	600mm	25mm	160ml	316L ss
5551S-1000	1000mm	25mm	300ml	316L ss
5551S-1500	1500mm	25mm	450ml	316L ss

Liquid Samplers

Snapper

Snaps Shut to Capture Sediment & Sludge

The Snapper has been specially designed to take samples of sediment and sludge in rivers, wells, tanks etc.

- Simple to use
- Holds approximately 250ml
- Automatically snaps shut on contact with the sediment
- Spring loaded mechanism
- Use with the telescopic pole that extends up to 4.5m

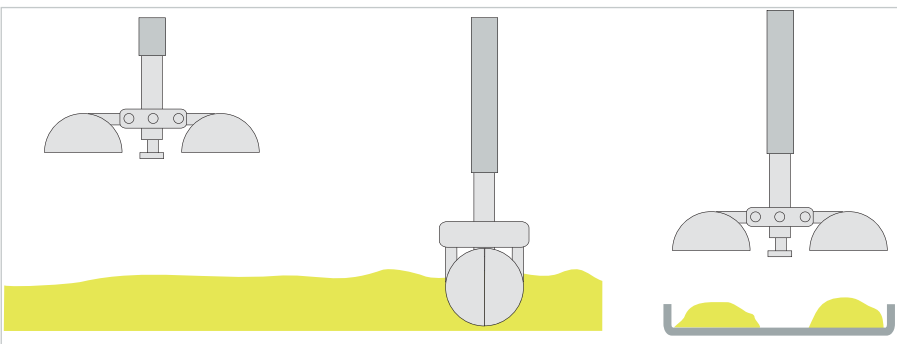

Part No.	Description
5061A-250	Snapper - 250ml sample volume
5061T-4500	Telescopic rod. Extends up to 4.5m

Deep Water Sampler - 2.5L

Large volume environmental sampler

The deep water sampler is ideal for liquid and water sampling. It can be used in tanks, wells, containers, rivers and the sea.

Operation is simple. As the sampler is lowered into the liquid the material flows through it. When you start to pull the rope the bottom valve closes which means you take a sample from that point.

To discharge the liquid simply open the valve on the side. The Deep Water sampler is quick and easy to use.

- Graduated
- Supplied with 15m rope
- Transparent so its easy to inspect what has been sampled
- Made from robust plexiglass
- Ideal for chemical and environmental sampling
- Stratified sampling is quick and easy

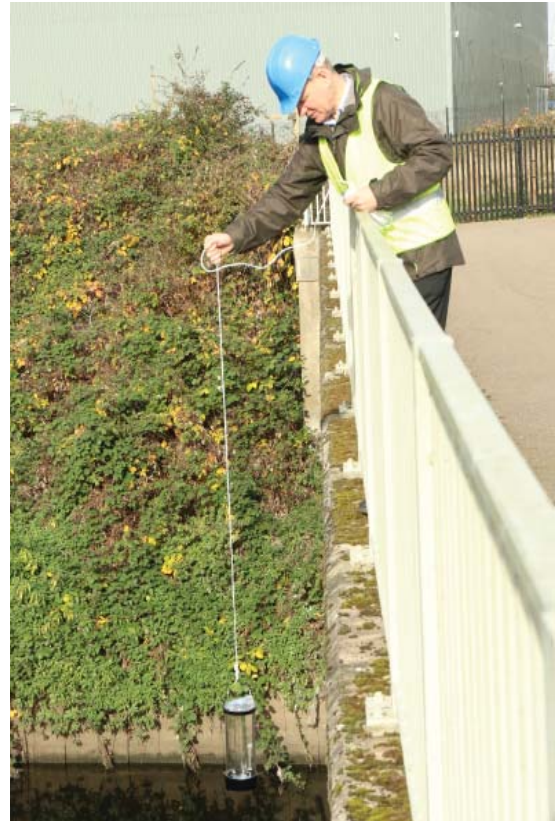

Part No.	Nominal Volume	Diameter	Height	Weight	Material
5079A-2500	2500ml	130mm	340mm	1.3Kg	Plastic - Plexiglass

In Stream Sampler



The In Stream Sampler is a useful piece of equipment for taking samples from a product that is flowing. Alternatively it can be used to take samples directly from containers or vessels.

The In Stream Sampler is made from robust 316L stainless steel. It can be used for sampling both powders and liquids.

- Multi purpose sampler
- 316L stainless steel
- Crevice free interior
- Available from stock
- Polished finish



Part No.	Nominal Volume	Internal Diameter	Handle Length
A996-500	500ml	80mm	1000mm



Utility Dipper

Simple Liquid Sampler

An all stainless steel sampler suitable for sampling liquids and suspensions.

- Takes a sample at the surface of the liquid
- Made from 316L Stainless steel

Operation

1. Insert the sampler into the product. The liquid will flow into the sampler.
2. Withdraw the sampler from the product
3. Raise the centre control rod to discharge the sample

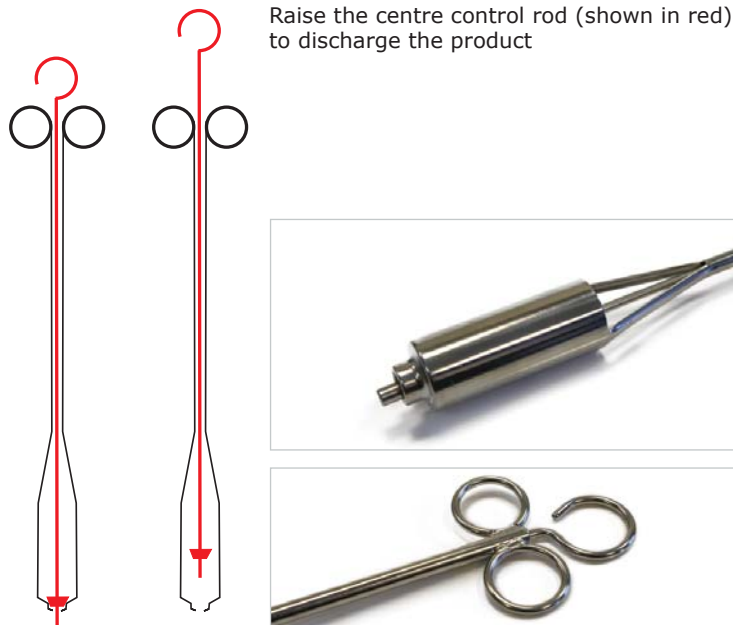

304

Part No.	Overall Length	Nominal Cup Volume	Max. Diameter of Cup
5170A-50	460mm	50ml	32mm
5170A-100	540mm	100ml	32mm



Do you have a good idea?

Sampling systems are always happy to hear your ideas and suggestions.

However big or small your idea please contact us. The concepts for many of the samplers in our range originated from customer feedback, requests and ideas.



Multi Dipper 2

Multilevel Liquid Sampler

The Multi Dipper 2 is the ideal solution for taking liquid samples from different levels. The sample collection bottles remain closed until the operator uses the control chain to remove the stoppers.

High security stainless steel shackles are used to secure the plugs to the control chain

Product contact parts are:

- Sampler frame 316L stainless steel
- Control Chain 316L stainless steel
- Plugs 316L stainless steel
- Plug Shackles 316L stainless steel
- Sample Bottle HDPE

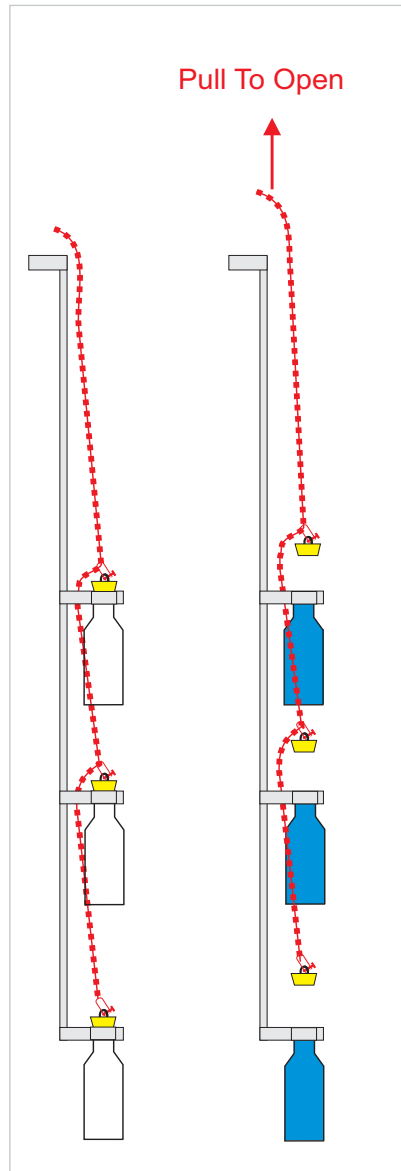

Operation

1. Screw the bottle into the holders
2. Insert the plugs into the tops of the sample bottles
3. Connect the Control Chain to the plugs
4. Insert the assembled sampler into the liquid to be sampled
5. Pull on the Control Chain to open the bottles
6. Remove from the liquid tank



Part No.	Overall Length	Bottles
5045A-1000	1000mm	3 x 250ml included (8165A-250)
5045A-1500	1500mm	3 x 250ml included (8165A-250)
5045A-2000	2000mm	3 x 250ml included (8165A-250)
8165A-250	Spare sample bottle - HDPE - 250ml	

Special sizes and designs are available on request



Enviro Dipper

The Enviro Dipper is a simple and yet effective method of taking a surface sample. Simply lower the bucket into the liquid.

The stainless steel bucket can be ordered with either a stainless steel chain or a braided polypropylene cord.

Part No.	Description
A725-300	Stainless Steel Bucket - 300ml
5070S-10	Chain - 316 stainless steel - 10m - with 316ss shackle
5070S-25	Chain - 316 stainless steel - 25m - with 316ss shackle
5070S-50	Chain - 316 stainless steel - 50m - with 316ss shackle
5070P-10	Braided Cord - Polypropylene 10m
5070P-25	Braided Cord - Polypropylene 25m
5070P-50	Braided Cord - Polypropylene 50m
5070D-04	Standard heavy duty hand reel



Standard Hand Reel



Need your Order Quickly?

95% of orders are shipped on the day the order is received.

We have deals with all the major express carriers so we can offer fast cost effective shipping worldwide. We can ship anywhere in Europe and the USA on a next day delivery. The Far East, Middle East and South America is generally 2 – 3 days shipping time.

To check stocks and confirm lead times please contact us.



U-D Doser

Accurate Unit Dose Sampling

Ideal for accurately sampling specific volumes of liquids. Designed specifically for unit dose sampling of liquids in the pharmaceutical industry.

- Suitable for sampling low to medium viscosity liquids.
- Ideal for low volume (unit dose) sampling.
- Made from Sampler body - 316 stainless steel, Syringe - PP & PE

Sample Chamber is designed so that the outside of the syringe is not contaminated during sampling. The syringe can therefore be used as a carrying container for taking the sample back to the laboratory.

Operation



1. Select a new syringe



2. Connect the syringe to the push rod



3. Attach outer cover. The sampler is now ready for use.



4. Pull up handle to take the sample, the graduations allow an accurate sample to be taken



Liquid Samplers



5ml U-D Doser		30ml U-D Doser		60ml U-D Doser		
Part No.	Length	Part No.	Length	Part No.	Length	
5010A-600	600mm	5010B-600	600mm	5010C-600	600mm	
5010A-1200	1200mm	5010B-1200	1200mm	5010C-1200	1200mm	
5010A-1800	1800mm	5010B-1800	1800mm	5010C-1800	1800mm	
Spare - 5ml syringes		Spare - 30ml syringes		Spare - 60ml syringes		
5010S-05	Pack of 100	5010T-30	Pack of 56	5010T-60	Pack of 40	
Options	Cleaning brushes	See page 184				
	Storage cases	See pages 186-187				
	XRF Certification	See page 196				

Stainless Dipper

GMP Correct Liquid Sampler

- 316L stainless steel construction
- Fully welded
- Satin finish



Part No.	Nominal Volume	Overall Length	Outside Cup Diameter
5005A-100	100ml	600mm	39mm
5005A-250	250ml	600mm	64mm
5005A-500	500ml	600mm	90mm
5005B-100	100ml	1000mm	39mm
5005B-250	250ml	1000mm	64mm
5005B-500	500ml	1000mm	90mm
5005C-100	100ml	1500mm	39mm
5005C-250	250ml	1500mm	64mm
5005C-500	500ml	1500mm	90mm



New sizes

PTFE Dipper

Excellent Chemical Resistance - GMP correct

- PTFE product contact parts
- Screw-in extension rods to increase the length of the handle



Part No.	Nominal Volume	Cup Diameter	Handle
5100A-100	100ml	55mm	600mm long - removable
5100A-250	250ml	70mm	600mm long - removable
5100A-500	500ml	80mm	600mm long - removable
5100A-1000	1000ml	105mm	600mm long - removable
5100E-600	Handle Extension rod - 600mm long		
5100E-1000	Handle Extension rod - 1000mm long		

New sizes



Chemical Dipper

Robust Polypropylene Dipper

- Ideal for general industrial applications
- Durable polypropylene construction



Part No.	Nominal Beaker Volume	Overall Length
5065F-250	250ml	1000mm
5065F-500	500ml	1000mm
5065F-1000	1000ml	1000mm



PTFE Mini Dipper

Excellent Chemical Resistance - GMP correct

Ideal for surface sampling small volumes of liquids

- PTFE construction
- Chemically resistant



Part No.	Nominal Volume	Cup Diameter	Handle
5100A-10	10mm	25mm	155mm long - fixed in place

Disposable Ladle

Efficient surface sampling of liquids

The SteriWare Ladle is ideal for the surface sampling of liquids. They can be used straight-from-the-bag; simply unwrap and use.

The one piece moulded design has been specially constructed to go through standard 2" lid bungs which are commonly found on barrels and kegs.

- Moulded & Packed in a Cleanroom
- Individually Bagged
- Made from FDA, EC 1935/2004 & EU 10/2011 conforming materials
- BSE/TSE Free
- Full Batch Traceability
- Available Sterile (gamma irradiated)
- Available from stock



Part No.	Nominal Volume	Diameter	Colour	Sterile	Material of Construction	Quantity per Box
8053H-50	50ml	48mm	Natural	No	HDPE	40
8053H-50S	50ml	48mm	Natural	Yes	HDPE	40
8053B-50	50ml	48mm	Blue	No	PP	40
8053B-50S	50ml	48mm	Blue	Yes	PP	40

Stainless Ladle

- Satin finish
- 304 or 316L stainless steel
- All stainless steel construction
- Crevice free construction



Part No.	Stainless Steel	Nominal Volume	Bowl Diameter	Handle Length
A326-150	316L	150ml	88mm	370mm
A324-50	304	50ml	63mm	275mm
A324-120	304	120ml	82mm	345mm
A324-150	304	150ml	92mm	350mm
A324-200	304	200ml	100mm	365mm

Sub Sampler

With Removable Glass Bottle

An ideal liquid sampler for most common liquids including water, oils, sludge etc.

- Manufactured from spark suppressant brass
- Bottle can be easily removed using patented click system
- 130mm diameter - 300mm high - 3 kg weight

Operation

1. Lower Sub Sampler to the required depth.
2. Pull up sharply on the lowering cable to pull the stopper out of the bottle.
3. Wait a few seconds for the liquid to flow into the bottle
4. Pull up the Sub Sampler and retrieve the sample



Part No.	Volume	Material	Dimensions (Diameter x Height)	Ex Rated
5073A-1000	1000ml	Nickel plated brass & glass	125 x 300mm	Yes*

* Make sure the sampler is properly earthed (grounded) use the Ex Hand Reel (5070D-05) and Copper cable (5070C)

Hand Reels, Cables & Chain

Hand reels and cables are essential accessories when using sub samplers (Bomb Samplers). The standard heavy duty hand reel is suitable for most situations. However if you are using the sampler in an Ex rated environment use the Hand Reel Ex with the copper cables.

Do not use stainless steel chain for use in ATEX environments.



Part No.	Description
5070D-04	Standard Heavy Duty Hand Reel - made from polypropylene
5070D-05	Ex Hand Reel - for Ex use rated environments. Made from conductive plastic. Supplied with earthing leads and clip. Use with copper cable (5070C)

Part No.	Description	Part No.	Description
5070S-10	Chain - 316 stainless steel - 10m	5070P-10	Polypropylene - braided cord - 10m
5070S-25	Chain - 316 stainless steel - 25m	5070P-25	Polypropylene - braided cord - 25m
5070S-50	Chain - 316 stainless steel - 50m	5070P-50	Polypropylene - braided cord - 50m
5070D-10	PTFE coated stainless wire - 10m	5070C-10	Copper - braided cable - 10m
5070D-25	PTFE coated stainless wire - 25m	5070C-25	Copper - braided cable - 25m
5070D-50	PTFE coated stainless wire - 50m	5070C-50	Copper - braided cable - 50m

Sub Sampler Pro

The Best Selling Heavy Duty Liquid Sampler

The Sub Sampler Pro (sometimes called a 'Bomb Sampler') is used throughout the world for both chemical and environmental sampling. Its unique double action means it can sample from a set distance from the bottom of a container or alternatively at a mid-point.



Liquid Samplers

A. Sample from the bottom of a container

- Use a **Lowering Cable**

The Sub Sampler Pro is lowered until the plunger assembly touches the bottom of the container. As the plunger assembly is pushed up the sample is able to enter the device. When the sampler is raised the plunger will drop down and seal the sampler.

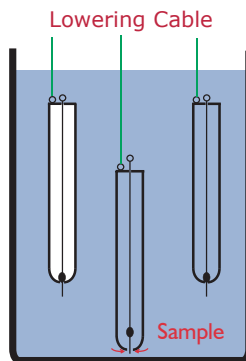

B. Mid-height Sampling

- Use a **Lowering Cable** and a **Control Line**

Lower the Sub Sampler Pro into the liquid. At the required sampling depth pull on the control line to raise the plunger. This will allow the liquid to enter the sampler. Release the control line and the plunger will drop down and seal the sampler.

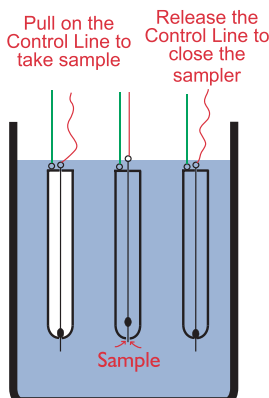

Part No.	Nominal Volume	Material	Diameter x Length	Ex Rated
5072B-500	500ml	316L Stainless steel	66 x 300mm	No
5072A-500	500ml	Nickel plated brass	50 x 430mm	No
5072A-1000	1000ml	Nickel plated brass	75 x 438mm	Yes*

* Make sure the sampler is properly earthed (grounded) use the Ex Hand Reel (5070D-05) and Copper cable (5070C)
Don't forget to order your Hand Reel and Cable - see page 106

Pasteur Pipette

The single use pipettes are ideal for taking small surface samples and for general laboratory use.

- Easy to use
- Made from Low Density Polyethylene (LDPE)
- Graduated
- Two convenient volumes
- Non-sterile



Part No.	Nominal Volume	Length	Quantity Per box
8134A-1	1ml	155mm	500
8134A-3	3ml	155mm	500

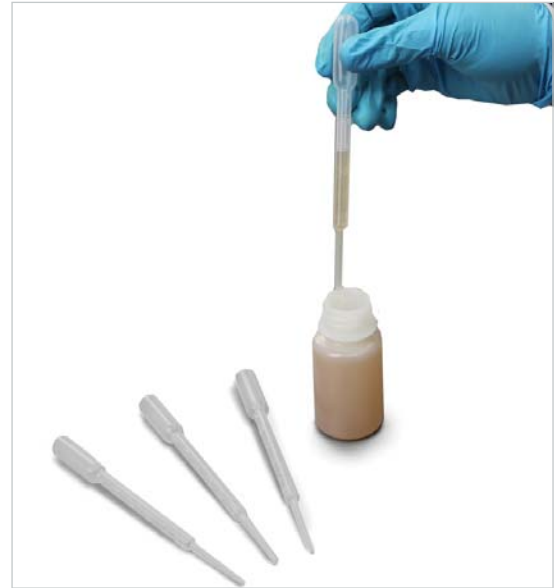

SteriWare LiquiDip

The Self Closing Liquid Sampler

The new disposable LiquiDip sampler from Sampling Systems is ideal for taking cross sectional samples of liquids. The special valve at the end of the sampler automatically closes when pushed against the bottom of the container.

- Individually bagged
- FDA and EC conforming material
- Cleanroom assembly and packing (ensures cleanliness)
- Available both sterile and non-sterile
- Available from stock for fast delivery worldwide

See Pages 46-47 for full details

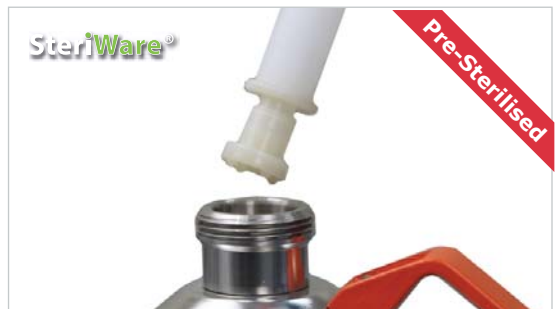

Part No.	Length	Nominal Capacity	Sterilised	Material	Quantity per Box
8921H-450	450mm	80ml	No	HDPE	20
8921H-450S	450mm	80ml	Yes	HDPE	20
8921H-1100	1100mm	225ml	No	HDPE	20
8921H-1100S	1100mm	225ml	Yes	HDPE	20

SteriWare LiquiThief

Single Use Disposable Liquid Sampler

- Ideal for sampling low viscosity liquids and oils
- Fully welded construction (no adhesives or screws are used)
- Assembled in a medical clean room
- Each sampler is individually wrapped
- Made from FDA acceptable polymers
- Simply pull the handle to take a sample



Part No.	Sampler Length	Sterile	Max. Sample Volume	Material	Outer Diameter	Quantity Per box
8050H-500	500mm	No	100ml	HDPE	21mm	20
8050H-1000	1000mm	No	190ml	HDPE	21mm	20
8050H-500S	500mm	Yes	100ml	HDPE	21mm	20
8050H-1000S	1000mm	Yes	190ml	HDPE	21mm	20
8050P-500	500mm	No	100ml	PP	21mm	20
8050P-1000	1000mm	No	190ml	PP	21mm	20

SteriWare Jumbo Pipettes

Low Cost Disposable Liquid Samplers

The Jumbo Pipette is both quick and easy to use. It is ideal for taking samples from low viscosity liquids. The Jumbo Pipette is part of our SteriWare® range.

- Simple to use
- Three convenient lengths
- Individually wrapped
- Assembled in a medical cleanroom
- Available pre-sterilised
- Made from HDPE (FDA acceptable grade conforms to CFR 177.1520)

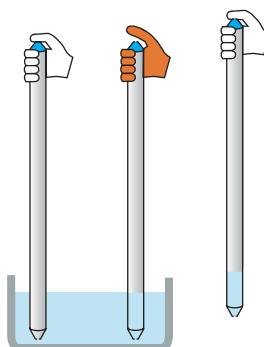

Part No.	Overall Length	Overall Diameter	Internal Diameter	Sterile	Max. Sample Volume	Material	Quantity per Box
8051H-450	450mm	21mm	17mm	No	80ml	HDPE	50
8051H-450S	450mm	21mm	17mm	Yes	80ml	HDPE	50
8051H-900	900mm	21mm	17mm	No	180ml	HDPE	50
8051H-900S	900mm	21mm	17mm	Yes	180ml	HDPE	50
8051H-1100	1100mm	21mm	17mm	No	225ml	HDPE	50
8051H-1100S	1100mm	21mm	17mm	Yes	225ml	HDPE	50

Easy Pumps

Economical and versatile pumps

The Easy Pump Range is ideal for many laboratory applications where small to medium quantities of liquid need to be pumped. Easy pumps are available either hand or foot operated.

Each pump is supplied with a Universal Bung - this allows the pump to be used with any container which has a round opening between 30 and 70mm.

These pumps are designed to be easy to install, easy to use and easy to clean.



Liquid Samplers

Hand Operated Easy Pumps

Part No.	Tube Diameter	Maximum length of Dip Tube	Tube Material	Capacity
5056A-18	18mm	700mm	Rigid PP	26L/min
5056A-12	12mm	700mm	Rigid PP	14L/min
5056B-16	16mm	700mm	Rigid PVDF	20L/min

Every EasiPump is supplied with a Universal Bung - for use with openings 30 to 70mm in diameter

Foot Operated Easy Pumps

Part No.	Tube Diameter	Maximum length of Dip Tube	Tube Material	Capacity
5058A-22	22mm	900mm	Rigid PP	30L/min
5058B-16	16mm	700mm	Rigid PVDF	20L/min
5058C-18	18mm	900mm	304 Stainless steel	26L/min

Every EasiPump is supplied with a Universal Bung - for use with openings 30 to 70mm in diameter

Stainless Pump

Stainless Barrel Pumps are ideal for quickly and easily transferring large volumes. The product contact parts of the pump are stainless steel (304 grade) and PTFE (for the piston gasket).

The Stainless Pump is ideal for hygienic applications.

Two Styles of Stainless Pump are available

Type 1 - Pump has a rigid stainless steel delivery tube

Type 2 - Pump has a flexible PTFE lined hose complete with a ball valve

Type 1 Part No.	Type 2 Part No.	Max. Submersible Length	Overall Length	Capacity
5900A-475	5900B-475	360mm	475mm	220ml/stroke
5900A-685	5900B-685	570mm	685mm	350ml/stroke
5900A-1030	5900B-1030	910mm	1030mm	560ml/stroke

Anti-Static Set Part No.: 8200A-05



Use the Anti-Static Set to ensure that the pump is properly earthed when working with flammable liquids.

Note: Don't forget to order a suitable pump connector - see below

PP Barrel Pump

PP Barrel Pumps are ideal for quickly and easily transferring large volumes.

Two styles of delivery pipe are available:

- **Type 1** with a rigid polypropylene delivery tube

- **Type 2** with a flexible PVC discharge tube (complete with stopcock)

Type 1 Part No.	Type 2 Part No.	Max. Submersible Length	Overall Length	Capacity
5900A-01	5900B-01	500mm	595mm	200ml/stroke
5900A-02	5900B-02	650mm	740mm	230ml/stroke
5900A-03	5900B-03	800mm	895mm	260ml/stroke
5900A-04	5900B-04	1000mm	1090mm	300ml/stroke
5900A-05	5900B-05	1250mm	1340mm	300ml/stroke



5900A-03



5900B-03

Note: Don't forget to order a suitable pump connector - see below

Pump Connectors



Brass Connector - R2" Internal Barrel Thread
Suitable for Stainless Barrel Pump
Part No. 8200S-01



PVC Bung - for 40 to 70mm openings
Suitable for either PP or Stainless Barrel Pumps
(only suitable for non flammable liquids)
Part No. 8200P-02



Gas Tight Barrel Connector - R2" Internal Barrel Thread & non-return valve with 1/8" thread
Suitable for Stainless Barrel Pump
Part No. 8200S-02



Tri-sure Internal Coarse Thread
Part No. 8200P-04



R2" Internal Steel Barrel Thread
Part No. 8200P-01



Mauser 2" Thread
Part No. 8200P-03

Part No.	Description	Suitable for Stainless Pump	Suitable for PP Pump
8200S-01	Brass Connector. R2"	Yes	No
8200S-02	Gas Tight Connector. R2"	Yes	No
8200P-02	PVC bung	Yes	Yes
8200P-01	PP Connector. R2".	Yes	Yes
8200P-03	PP Connector. Mauser 2"	Yes	Yes
8200P-04	PP Connector. Tri sure	Yes	Yes



In Line Sample Valve

Ideal for Sterile and Hygienic Sampling

The new range of in line sample valves are ideal for pharmaceutical, chemical and other hygienic industries.

Available for both CIP and non CIP. Designed for CIP (Clean in place) by steam. Alternatively remove the valve and quickly clean it with its GMP design.

- 316L stainless steel construction - contact parts
- Seal is chemically resistant. TFM FDA and EC conforming seal
- 150 C maximum working temperature
- Maximum 10 barg pressure
- Steamable in line
- Available from stock for fast delivery worldwide
- Finish Ra < 0.5 on wetted parts
- Supplied with a certificate of conformity as standard. Extra documentation such as Ra analysis, Material of construction documentation available as an extra cost option.
- PTFE Seal conforms to US3A and FDA CFR 21. PTFE gives a very high level of chemical resistance and durability



Liquid Samplers

Standard Sample Valve

Easy Clean Valve



Valve with standard turn handle



Valve with the safety auto return lever

The standard sample valve is ideal for general sampling. It can be quickly installed on to the pipe line or container.

The valve clamps into position. This enables it to be taken off quickly for cleaning.

It comes as standard with either a manual handle or auto return lever.

Part No.	Process Connection	Sample Port Connection	CIP Connection	Handle Type
5157A-05-H	1/2" Tri Clamp to BS4825	1/2" Tri Clamp to BS4825	N/A	Manual handle
5157A-05-L	1/2" Tri Clamp to BS4825	1/2" Tri Clamp to BS4825	N/A	Auto Return Lever

Options

Part No.	Description
5157-XRF	Material certification carried out by XRF. Per sampler
5157-RA	Ra Analysis. Per sampler

CIP Sample Valve

Version designed for Clean in Place



Valve with standard turn handle



Valve with the safety auto return lever

The CIP sample valve has been designed for aseptic sampling. High quality construction, manufacture and design means it can be quickly cleaned in position.

The valve is easy to operate. Simply turn the handle to take the sample.

The valve clamps into position. This enables it to be taken off quickly for cleaning.

It comes as standard with either a manual handle or auto return lever.

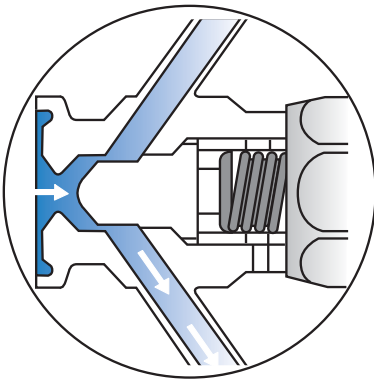

Sampling Phase

When the handle is opened the sample is taken.

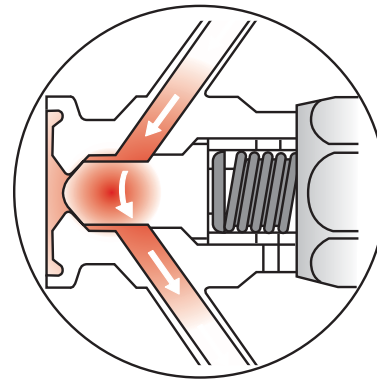

SIP/CIP Phase

After sampling the valve can be cleaned in place.

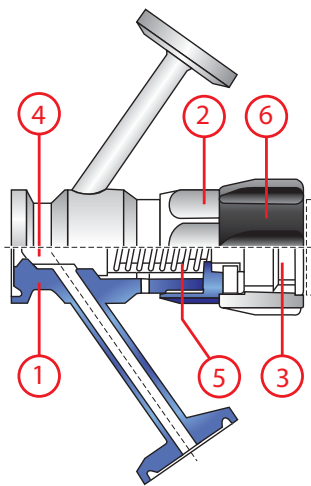
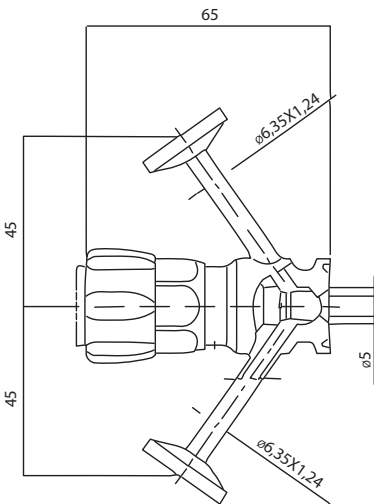

- 1) Valve Body - 316L stainless steel
- 2) Valve Head - 316L stainless steel
- 3) Stem - 316L stainless steel
- 4) PTFE membrane/seal
- 5) 304 stainless steel spring
- 6) Adjustable handle

Part No.	Process Connection	Sample Port Connection	CIP Connection	Handle Type
5157CIP-05-H	1/2" Tri Clamp to BS4825	1/2" Tri Clamp to BS4825	1/2" Tri Clamp to BS4825	Manual handle
5157CIP-05-L	1/2" Tri Clamp to BS4825	1/2" Tri Clamp to BS4825	1/2" Tri-Clamp to BS4825	Auto Return Lever

Options

Part No.	Description
5157-XRF	Material certification carried out by XRF. Per sampler
5157-RA	Ra Analysis. Per sampler

Road Tanker Sampling Valve

Safety Sampling Valve

The Road Tanker Sampling Valve is designed to allow road tankers to be safely sampled before the tank is discharged.

The Road Tanker valve is able to quickly connect to tanks that have been fitted with either a 2½" or a 3" BSP outlet.

The Road Tanker Sampling Valve is designed to allow road tankers to be safely sampled before the tank is discharged.



Operation

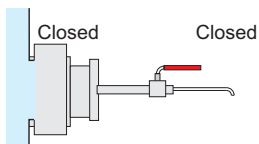

1. Connect the Road Tanker Sampling Valve to the main discharge valve on the road tanker.

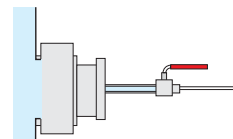

3. Close the main discharge valve

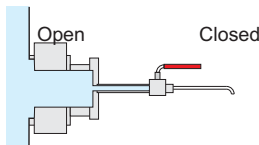

2. Ensure that the Sampling Valve is in the closed position, then open the main discharge valve

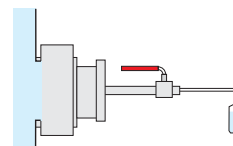

4. Open the sampling valve and collect the sample

Part No.	Tanker Connection	Outlet Valve Type	Material	Main Gasket Material
5740P-1	2½" BSP	Standard	316L ss	PTFE
5740P-2	2½" BSP	Firesafe	316L ss	PTFE
5740P-3	3" BSP	Standard	316L ss	PTFE
5740P-4	3" BSP	Firesafe	316L ss	PTFE

Disposable Bailer

Popular For Environmental Sampling

The sampler can either be manually pushed into the liquid or it can be lowered on the end of a cable. The Disposable Bailer is ideal for sampling from storage silos or from wells.

For viscous materials use the bailer fitted with an end weight (Part No. 5040W-1000)



The plastic ball in the end of the sampler is pushed out of the way when the sampler is lowered into the product.

When the sampler is removed the plastic ball seals the sampler.

Note: This sampler is not suitable for high density liquids

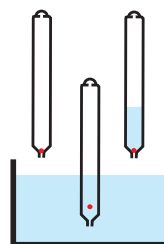

Part No.	Nominal Volume	Weighted End	Individually Bagged	Material	Length	Diameter	Quantity Per Box
5040A-1000	1000ml	No	Yes	HDPE	950mm	40mm	24
5040W-1000	1000ml	Yes	Yes	HDPE	950mm	40mm	24

Cables & Handle Reel see page 106

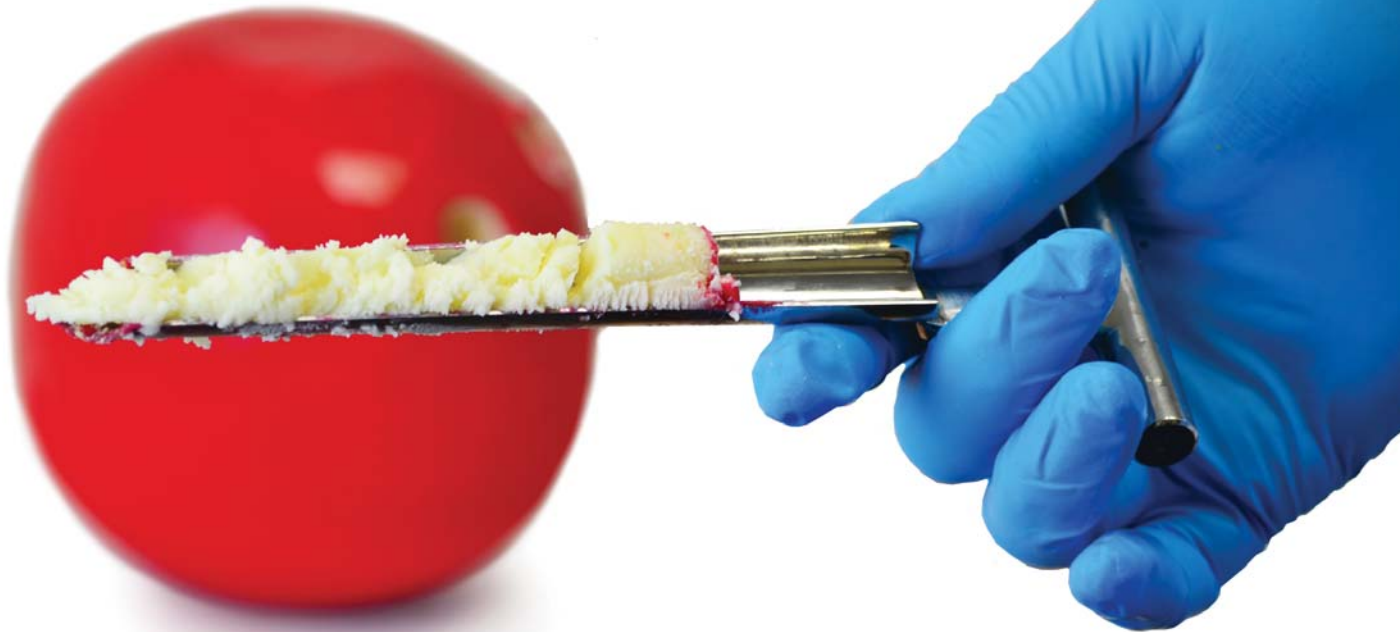

Semi-Solid Samplers



MiniCorer

- Suitable for sampling wax, cheese, greases, powders, granules
- Made from 316L stainless steel
- High quality bright polish finish
- Crevice free construction

Operation:

1. Rotate the handle as the sampler is pushed into the product. A core of the product will be cut.
2. Remove sampler.



Part No.	Sampler Length	Maximum Sampler Diameter	Stainless Steel
7008A-01	190mm	18mm	316L
7008A-02	235mm	18mm	316L
7008A-03	295mm	18mm	316L
8505A-12	Storage Case		

Corer

- Suitable for sampling wax, cheese, greases, powders, granules
- Made from 316L stainless steel
- High quality bright polish finish
- Crevice free construction

Operation:

1. Push the Outer tube into the product.
2. Use the Push Rod to eject the core of product from the Outer Tube

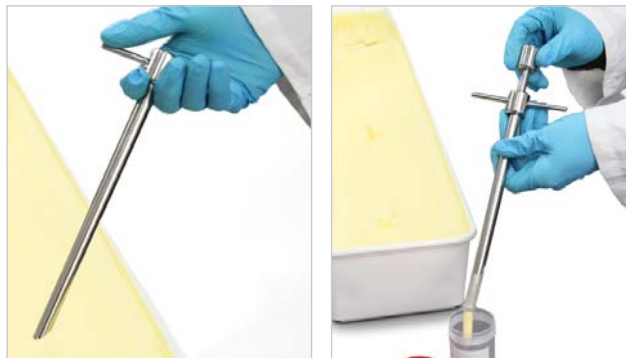

Part No.	Sampler Length	Maximum Sampler Diameter	Stainless Steel
7009A-01	230mm	12mm	316L
8505A-12	Storage Case		

Maxi Corers

- 316L stainless steel construction
- Two sizes
- Crevice free
- Satin finish

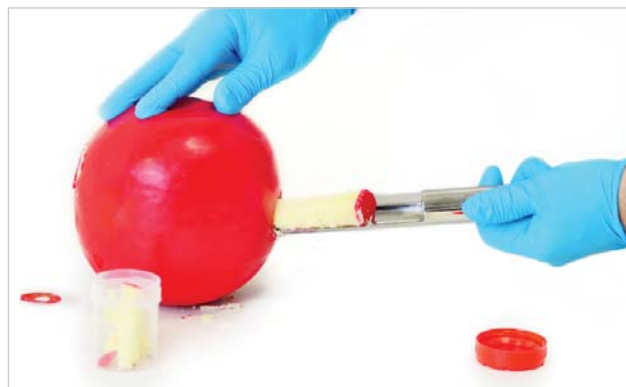

Part No.	Diameter	Overall Length	Blade Length	Stainless Steel
7010A-01	25mm	300mm	200mm	316L
7010A-02	25mm	600mm	500mm	316L

SteriWare ViscoThief

Single use Cream & Oil Sampler

Avoid time consuming cleaning with our disposable range of ViscoThief samplers. The Disposable ViscoThief is a single use sampler that is designed for use with viscous materials.

- Suitable for creams, pastes and gels
- 10mm diameter sampling hole in the tip
- Fully welded construction (no adhesives or screws are used)
- Assembled in a medical clean room
- Each sampler is individually wrapped
- Made from HDPE (FDA acceptable grade conforms to CFR 177.1520)
- FDA acceptable silicone rubber is used for the piston seal - CFR 177.2600

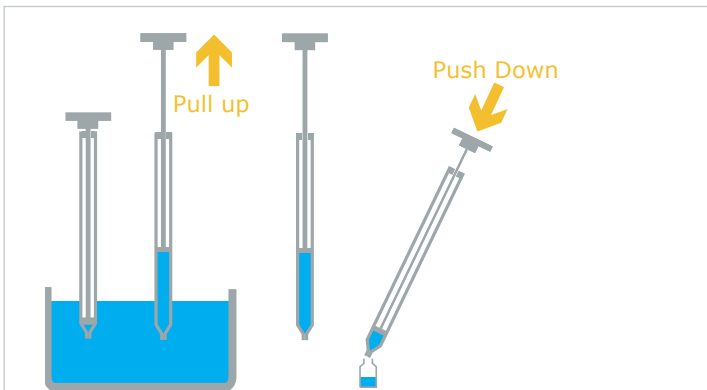

Operation:

1. Insert the sampler into the product
2. At the required depth pull up the handle. The sample will be drawn into the sampler
3. Withdraw sampler
4. Push down handle to expel the sample

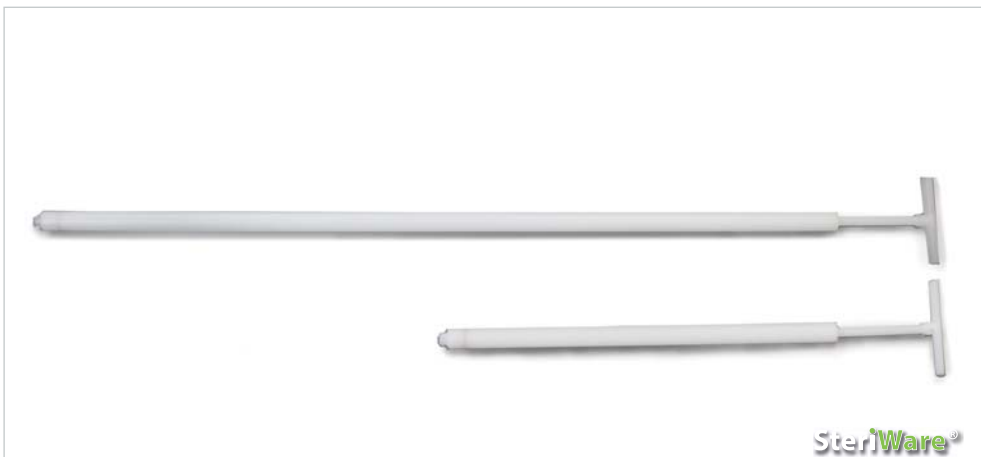

Part No.	Sampler Length	Sterile	Diameter of Hole in Tip	Max. Sample Volume	Material	Outer Diameter	Quantity per Box
8055H-500	500mm	No	10mm	100ml	HDPE	21mm	20
8055H-500S	500mm	Yes	10mm	100ml	HDPE	21mm	20
8055H-1000	1000mm	No	10mm	190ml	HDPE	21mm	20
8055H-1000S	1000mm	Yes	10mm	190ml	HDPE	21mm	20
8055H-1500	1500mm	No	10mm	290ml	HDPE	21mm	20
8055H-1500S	1500mm	Yes	10mm	290ml	HDPE	21mm	20

Semi-Solid Samplers

Viscous Sampler

Reusable Sampler for creams, pastes & gels,

Ideal for sampling creams, shampoos, soaps, honey and other semi viscous materials. After sampling the sampler can be completely dismantled into its component parts for quick and thorough cleaning.

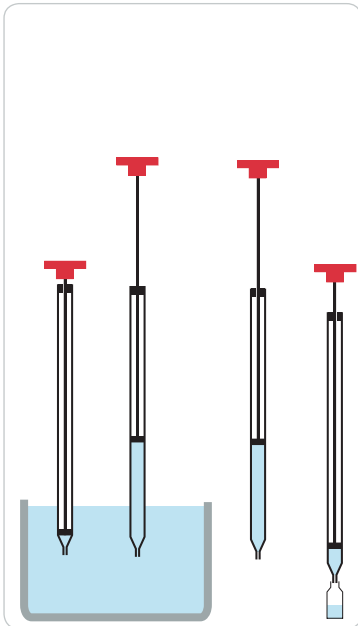

Operation:

1. Insert the sampler into the product.
2. At the required depth pull handle to draw product into the sampler.
3. Remove the sampler from the product. Run the cleaning ring down the sampler to remove any product that adheres to the side of the sampler
4. Push down the handle to push out the sample

Semi-Solid Samplers



Part No.	Overall Length	Material of Construction	Max. Sample Volume
7000S-600	600mm	316L stainless steel	160ml
7000S-1000	1000mm	316L stainless steel	300ml
7000S-1500	1500mm	316L stainless steel	450ml
7000P-600	600mm	PP	160ml
7000P-1000	1000mm	PP	300ml
7000P-2000	2000mm	PP	650ml
7000T-600	600mm	PTFE	160ml
7000T-1000	1000mm	PTFE	300ml
7000T-2000	2000mm	PTFE	650ml

Accessories	
Cleaning Brushes	See page 184
Storage Cases	See pages 186-187
XRF Certification	See page 196

See page 51 for a single use, disposable version of the Viscous Sampler

Note: For low viscosity liquids (e.g. water) use the Liquid Master - see pages 90-91

Ice Sampler

Best Selling Ice Sampler

The ice sampler was specially designed for sampling icy and waxy materials. The sample cover can be easily removed to give access to the sample.

- Suitable for sampling ice, wax and other similar materials
- Single point sampler
- Made from 316L stainless steel
- The sample cover can be quickly removed to allow quick emptying

Operation:

1. Rotate the handle as the sampler is pushed into the product. The scroll will cut into the product and the sample will be deposited in the sample collecting chamber.
2. Removing the cylinder allows the sample to be accessed.



Part No.	Length	Sample Volume	Diameter of Sampling head	Stainless Steel
6000A-300	300mm	50ml	40mm	316L
6000A-550	550mm	50ml	40mm	316L
6000A-1050	1050mm	50ml	40mm	316L
Storage Cases	See pages 186-187			
XRF Certification	See page 196			

Sample It

Label It



See pages 189-195 for our full range of labels

Ice Borer

Robust, efficient Ice Sampler

- Suitable for ice, wax and other similar materials
- Made from 316L stainless steel

Operation:

1. Rotate the handle as the sampler is pushed into the product. The sharp edge will cut into the product and the sample core will be deposited in the tube.
2. Push the Discharge Rod down the Ice Borer to remove the sample.



Sharp cutting tip of Ice Borer



Part No.	Description	Length	Outer Diameter	Material
6005A-500	Ice Borer	500mm	25mm	316L ss
6005A-1000	Ice Borer	1000mm	25mm	316L ss
8570A-700	Sample Discharge Rod	700mm	18mm	316L ss
8570A-1100	Sample Discharge Rod	1100mm	18mm	316L ss
Cleaning Brushes	See page 184			
Storage Case	See page 186			
XRF Certification	See page 196			

Semi-Solid Samplers



Wherever you are we are local

Visit
www.sampling.com
 for the latest news



Sample Lance

Durable Multi-purpose Sampler



The Sample Lance is ideal for taking cross sectional samples of pastes and soft waxy materials. It is manufactured from high quality 316L stainless steel.

The Sample Lance is available with a range of different handles. The Heavy Duty Handles is ideal when the powder is hard and dense. They give additional leverage when the sampler is pushed into the product. Sample Lances can be supplied without handles when the powder is light and fluffy. Heavy Duty handles are suitable for all other applications.

Operation is simple. Just push the sampler into the powder to take a core sample.

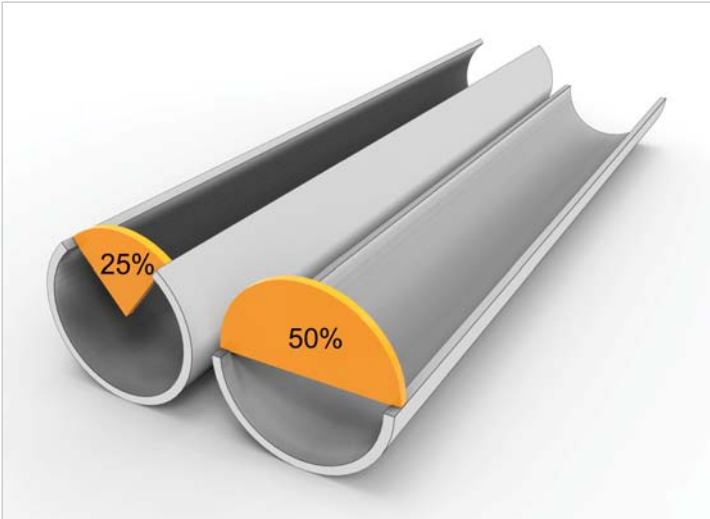

- Manufactured in 316L stainless steel
- Available in different sizes and handle combinations
- Can be used in the laboratory or on site
- Available from stock



Part No.	Length	Lance Opening Size	Handle Type	Width	Material
1660P-600	600mm	25%	Plain	25mm	316L ss
1660P-1000	1000mm	25%	Plain	25mm	316L ss
1665P-600	600mm	50%	Plain	25mm	316L ss
1665P-1000	1000mm	50%	Plain	25mm	316L ss
1660H-600	600mm	25%	Heavy Duty	25mm	316L ss
1660H-1000	1000mm	25%	Heavy Duty	25mm	316L ss
1665H-600	600mm	50%	Heavy Duty	25mm	316L ss
1665H-1000	1000mm	50%	Heavy Duty	25mm	316L ss

Ice Cream Sampler

The Ice Cream Sampler is ideal for sampling products like ice cream and soft waxes.

The Ice Cream Sampler has an all stainless steel construction and is designed to be easily dismantled for cleaning. The sampler comes complete with a plastic test tube.



Part No.	Diameter	Max. Sample Volume	Material of Construction
6006A-100	25mm	30ml	316L stainless steel with clear polystyrene test tube
6006A-101	Test Tube made from clear polystyrene (PS)		
8020J-600	Cleaning Brush		

Powered Ice Sampler

Efficient Large Volume Sampler



The Powered Ice Sampler is designed to be used with virtually any electric drill.

Manufactured from chemically resistant 316L stainless steel.

- Fits all standard electric drills (Note: drill not supplied)
- Takes samples in seconds
- Wide diameter for large cross sectional sample
- Available from stock
- Supplied with ejection rod



Part No.	Description	Max. Sample Volume	Length	Diameter	Material
6010A-240	Powered Ice sampler with discharge rod	400ml	240mm	50mm	316L ss

Note: The electric drill is not included

World Class Equipment
worldwide



Environmental Sampling



TeleScoop

The Extendable Sampler For Liquid Sampling

The TeleScoop is suitable for taking samples from liquids and suspensions.

A range of light weight, aluminium telescopic handles is available which makes this the ideal sampler to use when sampling from places such as: overhead gantries, river banks, water outlets etc.

The attachments are all interchangeable with the telescopic rods.



Attachments for telescopic rods



Angular Beaker 5065B

The beaker can be easily adjusted to the required angle



Stainless Beaker

Sampling beaker in a fixed position made from stainless steel



Pendulum Beaker 5065C

Always swings to the upright position



Bottle Holder 5065D

Suitable for bottles up to 95mm diameter. Price includes one 750ml LDPE bottle



Surface Net 5065M

310 x 280mm
Mesh size 2 to 5mm



Deep Catch Net 5065N

190 x 430mm
Mesh size 2 to 5mm



Multi Purpose

The heads can be quickly interchanged by our simple clip system.

Telescopic Rods

Easily adjustable to the required length.
Robust, light weight aluminium or stainless steel construction.



TeleScoop Rods



Part No.	Description	Length	Material
5065A-1200	Telescopic Rod	720 to 1200mm	Aluminium & plastic
5065A-2500	Telescopic Rod	1320 to 2500mm	Aluminium & plastic
5065A-2800	Telescopic Rod	1020 to 3000mm	Aluminium & plastic
5065A-3000	Telescopic Rod	1230 to 3000mm	Aluminium & plastic
5065A-4500	Telescopic Rod	1720 to 4500mm	Aluminium & plastic
5065A-6000	Telescopic Rod	1820 to 6000mm	Aluminium & plastic
5065S-1500	Telescopic Rod	800 to 1500mm	316L stainless steel & PTFE
5065S-3000	Telescopic Rod	1500 to 3000mm	316L stainless steel & PTFE
5065S-4500	Telescopic Rod	1500 to 4500mm	316L stainless steel & PTFE

TeleScoop Attachments & Spares



Part No.	Description	Volume	Material
5065B-600	Angular Beaker	600ml	Polypropylene
5065B-1000	Angular Beaker	1000ml	Polypropylene
5065B-2000	Angular Beaker	2000ml	Polypropylene
5065B-1000B	Angular Beaker	1000ml	304 Stainless Steel
5065C-600	Pendulum Beaker	600ml	Polypropylene
5065C-1000	Pendulum Beaker	1000ml	Polypropylene
5065C-2000	Pendulum Beaker	2000ml	Polypropylene
5065C-1000B	Pendulum Beaker	1000ml	304 Stainless Steel
5065D-750	Bottle Holder	750ml	Polypropylene & Aluminium, LDPE bottle
8125A-750	Spare Bottle	750ml	LDPE
5065M-310	Surface Catch Net	310 x 280mm	Polypropylene & Polyamide
5065N-190	Deep Catch Net	190 x 430mm	Polypropylene & Polyamide



Sub Sampler

With Removable Glass Bottle

An ideal liquid sampler for most common liquids including water, oils, sludge etc.

- Manufactured from spark suppressant brass
- Bottle can be easily removed using patented click system
- 130mm diameter - 300mm high - 3 kg weight

Operation

Lower sampler into liquid. Pull reel to lift stopper. This allows liquid to flow into the glass bottle. Remove sampler and remove bottle.



Part No.	Nominal Volume	Material	Dimensions (Diameter x Height)
5073A-1000	1000ml	Nickel plated brass & glass	125 x 300mm

See below for cables and reels

Hand Reels, Cables & Chain

Hand reels and cables are essential accessories when using sub samplers (Bomb Samplers). The standard heavy duty hand reel is suitable for most situations. However if you are using the sampler in an Ex rated environment use the Hand Reel Ex with the copper cables.

Do not use stainless steel chain in ATEX environments.



Part No.	Description
5070D-04	Standard Heavy Duty Hand Reel - made from polypropylene
5070D-05	Ex Hand Reel - for Ex use rated environments. Made from conductive plastic. Supplied with earthing leads and clip. Use with copper cable (5070C)

Part No.	Description
5070S-10	Chain - 316 stainless steel - 10m
5070S-25	Chain - 316 stainless steel - 25m
5070S-50	Chain - 316 stainless steel - 50m
5070D-10	PTFE coated stainless wire - 10m
5070D-25	PTFE coated stainless wire - 25m
5070D-50	PTFE coated stainless wire - 50m

Part No.	Description
5070P-10	Polypropylene - braided cord - 10m
5070P-25	Polypropylene - braided cord - 25m
5070P-50	Polypropylene - braided cord - 50m
5070C-10	Copper - braided cable - 10m
5070C-25	Copper - braided cable - 25m
5070C-50	Copper - braided cable - 50m

Sub Sampler Pro

The Best Selling Heavy Duty Liquid Sampler

The Sub Sampler Pro (some times called a 'Bomb Sampler') is used throughout the world for both chemical and environmental sampling. Its unique double action means it can sample from a set distance from the bottom of a container or alternatively at a mid point in a container or well for example.

A. Sample from the bottom of a container

- Use a **Lowering Cable**

The Sub Sampler Pro is lowered until the plunger assembly touches the bottom of the container. As the plunger assembly is pushed up the sample is able to enter the device. When the sampler is raised the plunger will drop down and seal the sampler.

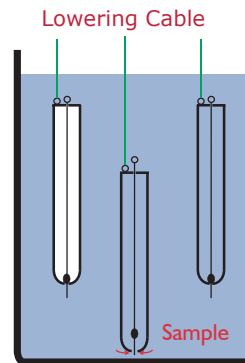

Liquid flows in when the sampler hits the bottom

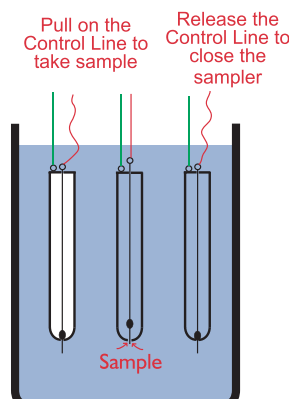

B. Mid-height Sampling

- Use a **Lowering Cable** and a **Control Line**

Lower the Sub Sampler Pro into the liquid. At the required sampling depth pull on the control line to raise the plunger. This will allow the liquid to enter the sampler. Release the control line and the plunger will drop down and seal the sampler.



Part No.	Nominal Volume	Material	Diameter x Length	Ex Rated
5072B-500	500ml	316L Stainless steel	66 x 300mm	No
5072A-500	500ml	Nickel plated brass	50 x 430mm	No
5072A-1000	1000ml	Nickel plated brass	75 x 438mm	Yes*

* Make sure the sampler is properly earthed (grounded) use the Ex Hand Reel (5070D-05) and Copper cable (5070C)

Don't forget to order your Hand Reel and Cable - see page 126

Soil Sampler Pro

Cross Sectional Soil Sampler

The Soil Sampler Pro is ideal for a wide range of soil sampling environments. It is built from high quality 316L stainless steel and comes with a wide robust handle which makes sampling easier.

The sampler comes with an optional discharge rod to help push soil out of the sampler after use.

- Lawns, meadows, light to medium soils
- Cross sectional sample
- Max Sample Volume: 170ml (approx.)
- Manufactured from high quality 316 stainless steel which means it is suitable for the toughest environments (including salty seawater areas)
- Wide Handles provide extra leverage

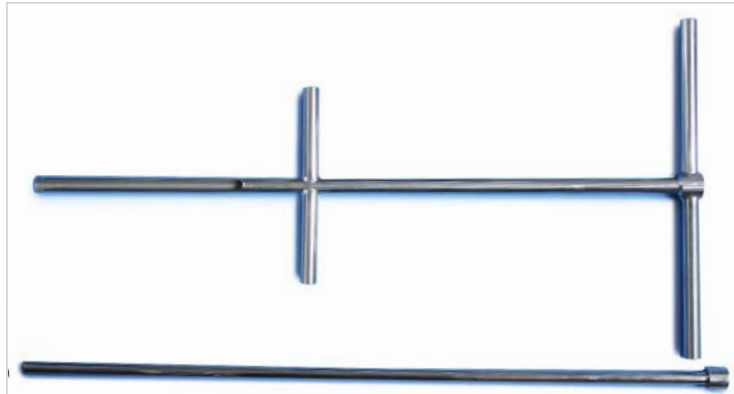

1. Push the sampler into the product
2. Rotate handle
3. Remove sampler
4. Use discharge rod to push sample out



Part No.	Description	Overall Length	Material	Diameter
1620A-01	Soil Sampler Pro	1000mm	316L stainless steel	25mm
8570A-1100	Sample Discharge Rod	1100mm	316L stainless steel	20mm

Enviro Dipper

The Enviro Dipper is a simple and yet effective method of taking a surface sample. Simply lower the bucket into the liquid.

The stainless steel bucket can be ordered with either a stainless steel chain or a braided polypropylene cord.



Part No.	Description
A725-300	Stainless Steel Bucket - 300ml
5070S-10	Chain - 316 stainless steel - 10m - with 316ss shackle
5070S-25	Chain - 316 stainless steel - 25m - with 316ss shackle
5070S-50	Chain - 316 stainless steel - 50m - with 316ss shackle
5070P-10	Polypropylene - Braided Cord - 10m
5070P-25	Polypropylene - Braided Cord - 25m
5070P-50	Polypropylene - Braided Cord - 50m
5070D-04	Standard heavy duty hand reel (polypropylene)

New

Grain Spear

Grain Sampler with Spiral Pockets



Highly representative sampling is fast and simple with our aluminium Sample Spear.

The spiral position of the pockets give superior sampling results. This means the bottom pocket opens and fills first giving a more representative sample.

The sampler is particularly suited for larger powders, granule and grain sampling. This can be from IBC, kegs, silos, railway trucks, ships and almost all applications

The lightweight aluminium construction means even the long samplers are easy to operate and handle. The tip is fixed permanently so it can not become loose and get lost.

- Aluminium
- Robust Construction
- Available from stock. Fast delivery worldwide

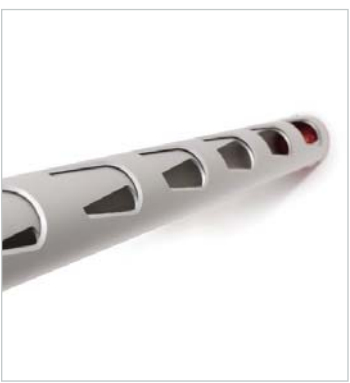

Sampler



Part No.	Length	Diameter	No. of Pockets	Material
1942A-1000	1000mm	35mm	4	Aluminium
1942A-1500	1500mm	35mm	6	Aluminium
1942A-2000	2000mm	35mm	8	Aluminium
1942A-2500	2500mm	35mm	10	Aluminium
1942A-3000	3000mm	35mm	12	Aluminium

Popular Accessories

To help push the sampler in we can offer a heavy duty handle. This means extra leverage can be used to push the sample thief making sampling even easier.

Part No.	Description
1942H-35	Heavy Duty Handle for 35mm diameter
8020J-1100	Cleaning brush. 1100mm long
8020J-1600	Cleaning brush. 1600mm long
8020J-2100	Cleaning brush. 2100mm long



Environmental

Cereal Trier (Slot Sampler)

- Multilevel sampler of grains, cereals and powders
- 316L stainless steel manufacture
- Robust design
- Available from stock



Part No.	Sampler Length	Outer Diameter	Maximum Sample Volume	Number of Slots
1210A-300	300mm	25mm	45ml	3
1210A-600	600mm	25mm	110ml	3
1210A-1000	1000mm	25mm	190ml	4
1210A-1500	1500mm	25mm	300ml	5
1210A-2000	2000mm	25mm	370ml	5
1210K-1000	1000mm	40mm	750ml	3
1210K-1500	1500mm	40mm	1000ml	4
1210K-2000	2000mm	40mm	1300ml	4



Environmental

Snapper

Snaps Shut to Capture Sediment & Sludge

The Snapper has been specially designed to take samples of sediment and sludge in rivers, wells, tanks etc.

- Simple to use
- Holds approximately 250ml
- Automatically snaps shut on contact with the sediment
- Spring loaded mechanism
- Use with the telescopic pole that extends up to 4.5m

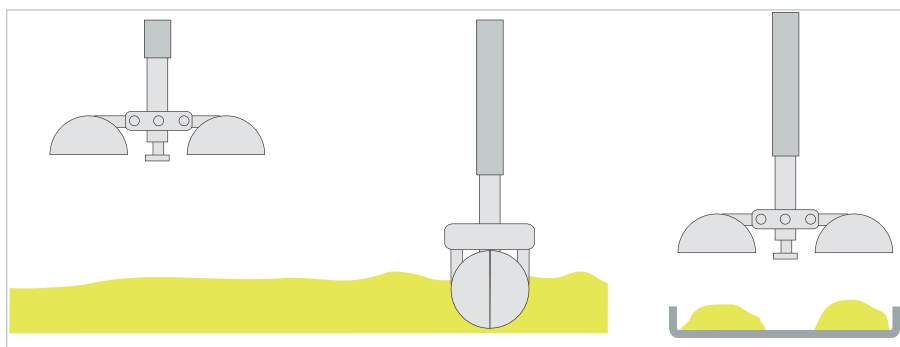

Part No.	Description
5061A-250	Snapper - 250ml sample volume
5061T-4500	Telescopic rod. Extends up to 4.5m

Deep Water Sampler - 2.5L

Large volume environmental sampler

The deep water sampler is ideal for liquid and water sampling. It can be used in tanks, wells, containers, rivers and the sea.

Operation is simple. As the sampler is lowered into the liquid the material flows through it. When you start to pull the rope the bottom valve closes which means you take a sample from that point.

To discharge the liquid simply open the valve on the side. The Deep Water sampler is quick and easy to use.

- Graduated
- Supplied with 15m rope
- Transparent so its easy to inspect what has been sampled
- Made from robust plexiglass
- Ideal for chemical and environmental sampling
- Stratified sampling is quick and easy

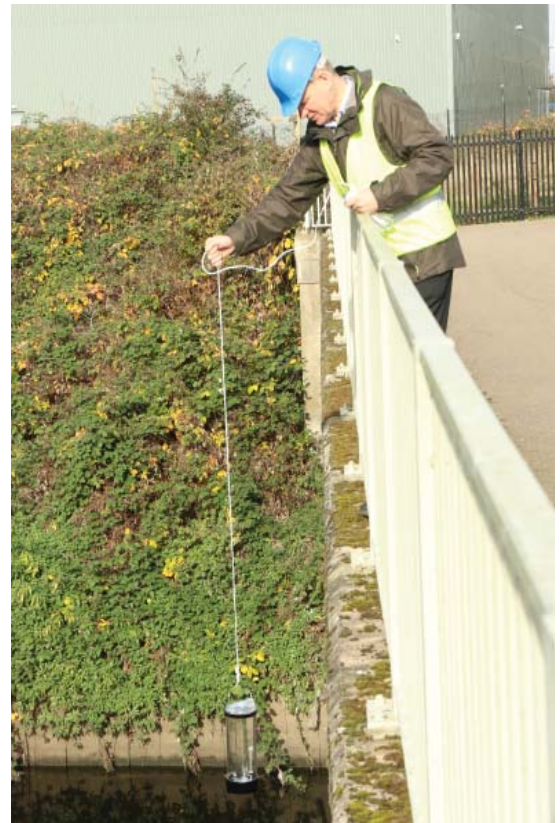

Part No.	Nominal Volume	Diameter	Height	Weight	Material
5079A-2500	2500ml	130mm	340mm	1.3Kg	Plastic - Plexiglass

In-Stream Sampler



The In-Stream Sampler is a useful piece of equipment for taking samples from a product that is flowing. Alternatively it can be used to take samples directly from containers or vessels.

The In-Stream Sampler is made from robust 316L stainless steel. It can be used for sampling both powders and liquids.

- Multi purpose sampler
- 316L stainless steel
- Crevice free interior
- Available from stock
- Polished finish



Part No.	Nominal Volume	Internal Diameter	Handle Length
A996-500	500ml	80mm	1000mm



Disposable Bailer

Popular For Environmental Sampling

The sampler can either be manually pushed into the liquid being sampled or else it can be lowered on the end of a wire. Ideal for sampling from storage silos or well sampling.

For viscous materials use the bailer fitted with an end weight (Part No. 5040W-1000)

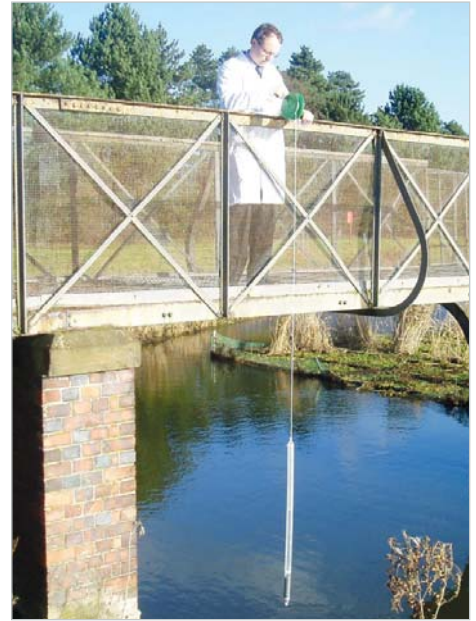

Disposable Bailer without an end weight

The plastic ball in the end of the sampler is pushed out of the way when the sampler is lowered into the product.

When the sampler is removed the plastic ball seals the sampler.

Note: This sampler is not suitable for high density liquids

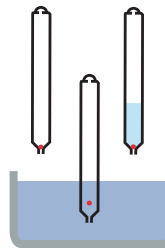

See page 126 for Lowering Cables and Hand Reels



Part No.	Nominal Volume	Weighted End	Individually Bagged	Material	Length	Diameter	Quantity Per Box
5040A-1000	1000ml	No	Yes	HDPE	950mm	40mm	24
5040W-1000	1000ml	Yes	Yes	HDPE	950mm	40mm	24

Environmental

Sample Kit

The Sampling Systems sample kit is ideal if you want a pre packed sample kit. In each over bag is an individually bagged sterile scoop and robust sterile sample bag (with metal closure system).

Ideal for taking samples of soil etc. The sample bag has a metal closure to seal the bag.



Part No.	Nominal Scoop Volume	Scoop Material	PureBag Material	Qty per box
8480A-30S	30ml	PS (sterile)	LDPE (sterile)	10 scoops & 10 PureBags

Auger Soil Sampler

Robust Soil Sampling

The Sampling Systems range of auger samplers are ideal for soil sampling. The Auger Soil Sampler is made from painted steel.

Simply rotate the sampler into the soil to take a sample.

- Made from robust painted steel
- Available from stock
- Different sized heads can be attached to the standard handle
- Fast delivery worldwide



Part No.	Description
4710A-100	Auger Soil Sampler Head - 100mm diameter - painted steel
4710A-150	Auger Soil Sampler Head - 150mm diameter - painted steel
4710H-1000	T handle with rod 1000mm length - painted steel

Dutch Auger Soil Sampler

Made From Stainless Steel

The Dutch Auger Soil Sampler is ideal for general soil sampling. It can be supplied as individual components or a cost effective set with carrying bag.

Different heads can be easily attached to the same body. 75mm and 100mm diameter heads are available from stock.



Part No.	Description
2750K-01	Dutch Auger Soil Sampler Kit (Including 75mm and 100mm diameter heads, T handle, pallet knife, spanner, gloves and carry bag)
2750A-75	Dutch Auger Soil Sampler Head - stainless steel - 75mm diameter
2750A-100	Dutch Auger Soil Sampler Head - stainless steel - 100mm diameter
2750H-1000	T Handle with rod - 1000mm length



Bottles & Containers



Wide Mouth Containers



- Popular container for storing and transporting samples
- Suitable for use with powders and liquids
- HDPE Body with PP Lid
- Wide mouth design
- Translucent
- Made from food grade and FDA compliant material
- Certified BSE/TSE free
- Watertight



Part No.	Nominal Volume	Diameter	Quantity Per box
8126H-30	30ml	37mm	12
8126H-60	60ml	39mm	12
8126H-125	125ml	51mm	12
8126H-250	250ml	62mm	12
8126H-500	500ml	73mm	12
8126H-1000	1000ml	92mm	6
8126H-2000	2000ml	120mm	6

Multi Purpose Bottles PP



- Watertight container
- PP Body and Lid
- Made from food grade and FDA compliant material
- Translucent



Part No.	Nominal Volume	Diameter	Quantity Per box
8121P-4	4ml	15mm	12
8121P-8	8ml	25mm	12
8121P-15	15ml	25mm	12

PP Tubs



- General purpose powder container
- White
- Crevice free interior



Part No.	Nominal Volume	Diameter
8180A-12	12ml	25mm
8180A-25	25ml	31mm
8180A-60	60ml	41mm
8180A-90	90ml	52mm
8180A-120	120ml	52mm
8180A-250	250ml	52mm
8180A-600	600ml	90mm
8180A-1000	1000ml	117mm



Sample Containers



- Versatile container
- PP Body with HDPE Lid
- Suitable for Liquid and powders
- Low cost

Note:

- 50ml container is powder-tight & watertight
- 100ml container is powder-tight only



Part No.	Nominal Volume	Quantity Per box
8131A-50	50ml	384
8131A-100	100ml	280

Wide Mouth Amber Bottles



- Amber Colour
- Suitable for use with powders and liquids
- HDPE Body with PP Lid
- Wide mouth design
- Watertight



Part No.	Nominal Volume	Diameter	Quantity Per box
8126H-30A	30ml	37mm	72
8126H-60A	60ml	39mm	72
8126H-125A	125ml	51mm	72
8126H-250A	250ml	62mm	72
8126H-500A	500ml	73mm	48
8126H-1000A	1000ml	92mm	24

Carboys



The Sampling Systems Carboys are manufactured from heavy duty polypropylene which is not only very tough physically but also has good chemical resistance.

- Available with or without stopcock
- All polymers are FDA compliant and USP Class VI
- Certified BSE/TSE free
- Can be autoclaved



Part No.	Nominal Volume	Stopcock Included	Diameter	Height
8132P-10	10 litres	No	250mm	390mm
8132P-10T	10 litres	Yes	250mm	390mm
8132P-20	20 litres	No	290mm	530mm
8132P-20T	20 litres	Yes	290mm	530mm

Wide Mouth Square Bottle



- Polypropylene Body & Cap
- All polymers are FDA compliant Screw-on cap
- Watertight
- Can be Autoclaved
- Supplied as 6 bottles per box



Part No.	Nominal Volume	Height	Width	Internal Neck Diameter
8235P-4000	4000ml	305mm	150mm	90mm

Aluminium Bottles



- Anodised Aluminium body
- PP cap with internal aluminium seal
- Screw-on cap
- Watertight



Part No.	Nominal Volume	Height	Diameter
8110A-60	60ml	88mm	40mm
8110A-120	120ml	97mm	57mm
8110A-300	300ml	160mm	57mm
8110A-600	600ml	192mm	74mm
8110A-1200	1200ml	248mm	88mm

PTFE Pot



- Multi purpose containers & cap
- Crevice free interior
- Heavy wall construction



Part No.	Nominal Volume	Height	Diameter
A115-15	15ml	34mm	32mm
A115-30	30ml	62mm	32mm
A115-60	60ml	46mm	54mm
A115-120	120ml	62mm	62mm
A115-240	240ml	100mm	66mm
A115-480	480ml	125mm	80mm
A115-1000	1000ml	160mm	101mm
A115-2200	2200ml	260mm	120mm

PTFE Bottle



- Multi purpose bottle & cap
- Crevice free interior
- Heavy wall construction



Part No.	Nominal Volume	Height	Diameter
A125-1	1ml	27mm	16mm
A125-5	5ml	35mm	22mm
A125-10	10ml	50mm	26mm
A125-25	25ml	61mm	33mm
A125-50	50ml	76mm	43mm
A125-100	100ml	88mm	52mm
A125-250	250ml	115mm	67mm
A125-500	500ml	150mm	80mm
A125-1000	1000ml	185mm	100mm
A125-2000	2000ml	240mm	120mm

PureBag Sterile Bags With metal Closure System

Our range of sterile PureBags are an ideal low cost alternative to standard containers. They have a robust metal closure system for easy and secure closing.

- Sterile
- Leak-proof with unique metal closure system
- Made from a special super tough grade of LDPE
- Complies with FDA, USDA and HACCP guidelines
- Pyrogen free
- Suitable up to 80°C
- Wide range of sizes available from stock



Part No. (plain)	Part No. (with labelling area)	Nominal Volume	Width	Length	Quantity Per box
8080A-60	8080L-60	60ml	76mm	127mm	1000
8080A-150	8080L-150	150ml	76mm	178mm	1000
8080A-450	8080L-450	450ml	114mm	229mm	1000
8080A-900	8080L-900	900ml	114mm	305mm	1000
8080A-1200	8080L-1200	1200ml	114mm	382mm	1000
8080A-5500	N/A	5500ml	305mm	406mm	250
8080A-10500	N/A	10500ml	305mm	610mm	250

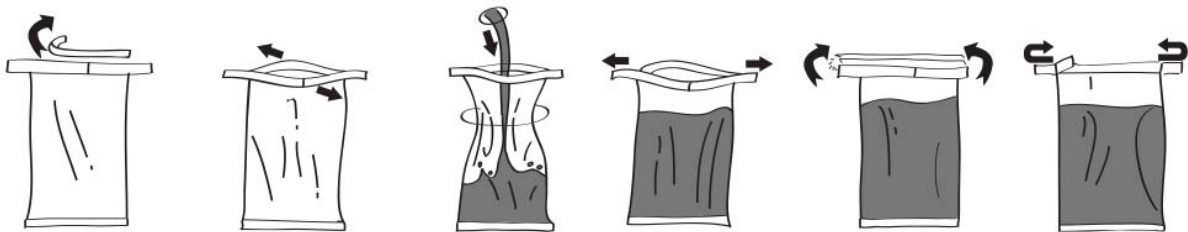

Pure Bag - Stand Up Sterile Free-Standing Bags

The Stand Up range makes transferring samples very easy. The Bags are designed so that stand up without any additional support.

- Sterile
- Leak-proof with unique metal closure system
- Made from a special super tough grade of PET
- Complies with FDA, USDA and HACCP guidelines
- Pyrogen free
- Suitable up to 80°C
- Available from stock
- Metal closure system for secure sealing



Part No.	Nominal Volume	Width	Length	Quantity Per box
8079A-450	400ml	114mm	229mm	1000
8079A-600	600ml	114mm	290mm	1000



SteriWare® Powder Bottles



Powder Bottles are a new premium, single use, screw top bottle from Sampling Systems. They are designed to meet the requirements of the pharmaceutical industry.

The Powder Bottles are made in a cleanroom to ensure cleanliness. They are all individually bagged.

- Powder tight
- Available in 250ml and 500ml sizes
- Other sizes to follow
- Manufactured, inspected & packed in a Cleanroom
- Individually Bagged
- FDA Conforming Materials
- BSE/TSE Free
- Full Batch Traceability
- Available Sterile (gamma irradiated)



Part No.	Nominal Volume	Sterile	Overall Height	Outer Diameter	Material	Quantity Per box
8890P-250	250ml	No	88mm	76mm	PP	50
8890P-250S	250ml	Yes	88mm	76mm	PP	50
8890P-500	500ml	No	106mm	94mm	PP	37
8890P-500S	500ml	Yes	106mm	94mm	PP	37

Sampling Bags

Non-Sterile Bags

The range of general purpose sampling bags from Sampling Systems are made from clear food grade polyethylene (PE). Suitable for food, chemical and pharmaceutical products. The bags come with an easy closure system along the top

- Supplied in packs of 100
- Made from FDA and EU conforming PE
- Range of convenient sizes
- Available from stock

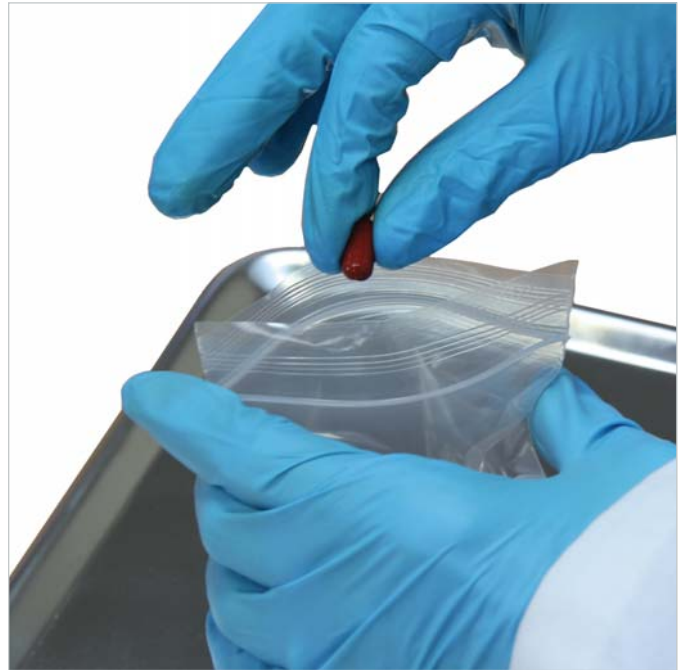

Part No.	Dimensions	Quantity Per Pack
8246L-100	100 x 140mm	100
8246L-150	150 x 230mm	100
8246L-200	200 x 280mm	100
8246L-250	250 x 350mm	100
8246L-300	330 x 460mm	100





Web Site – For the Latest Products

Our web site is constantly being updated with the latest products.
 For more info please see **www.sampling.com**

Mini-Pots



Mini-Pots are high quality containers that are made from 316L stainless steel. Mini-Pots have a crevice free interior and widely used in pharmaceutical and chemical laboratories around the world.

Mini-Pots are available in a wide range of sizes.

- Screw on lid
- Satin finish
- Multi purpose small volume containers
- 316L stainless steel
- Crevice free interior
- O ring available for improved sealing



Part No.	Nominal Volume	Body Diameter	Overall Height	Stainless Steel
A426-7	7ml	19mm	45mm	316L
A426-25	25ml	41mm	36mm	316L
A426-50	50ml	42mm	53mm	316L
A426-100	100ml	52mm	73mm	316L
A426-250	250ml	77mm	73mm	316L
A426-500	500ml	102mm	78mm	316L
A426-750	750ml	102mm	116mm	316L
A426-1000	1000ml	102mm	154mm	316L



Part No.	Suit Nominal Volume	Material
A426-25S	O ring for 25ml (A426-25)	Silicone
A426-50S	O ring for 50ml (A426-50)	Silicone
A426-100S	O ring for 100ml (A426-100)	Silicone
A426-250S	O ring for 250ml (A426-250)	Silicone
A426-500S	O ring for 500ml (A426-500)	Silicone
A426-750S	O ring for 1000ml (A426-750)	Silicone
A426-1000S	O ring for 50ml (A426-1000)	Silicone

Mini-Pots can be fitted with a silicone O ring. This makes the sealing more robust. The silicone is FDA compliant to CFR 177.2600.



Stainless Beakers (316L)



Our range of stainless steel beakers are made from high grade 316L stainless steel. Available in 4 convenient sizes in a polished finish. Ideal for use in the laboratory or production environment. These multi-purpose stainless steel beakers are ideal for the collection and storage of powders and liquids.

- Multi purpose containers
- 316L stainless steel
- Crevice free interior
- Available from stock
- Polished finish (Ra < 0.5 microns)



Part No.	Nominal Volume	Internal Diameter	Height	Stainless Steel
A736-500	500ml	80mm	97mm	316L
A736-1000	1000ml	100mm	145mm	316L
A736-2000	2000ml	150mm	150mm	316L
A736-3000	3000ml	200mm	100mm	316L

Powder Pots (316L Stainless)



The Sampling Systems range of Powder Pots are made from 316L stainless steel. Powder Pots have a screw on lid and are available in 4 sizes. The high quality polished finish means that they are ideal for use in laboratories or production environments.

- Multi purpose screw top containers
- 316L stainless steel
- Crevice free interior
- Available from stock
- Polished finish (Ra < 0.5 microns)



Part No.	Nominal Volume	Max Diameter	Height	Stainless Steel
A166-250	250ml	80mm	70mm	316L
A166-500	500ml	106mm	72mm	316L
A166-750	750ml	106mm	97mm	316L
A166-1000	1000ml	106mm	148mm	316L

Pots with Lids



- 304 stainless steel
- Crevice free
- Simple drop on lid
- Satin finish



Part No.	Nominal Volume	Top Diameter	Height	Stainless Steel
A284-400	400ml	85mm	85mm	304
A284-650	650ml	100mm	100mm	304
A284-1250	1250ml	120mm	120mm	304
A284-2500	2500ml	150mm	150mm	304
A284-5000	5000ml	200mm	200mm	304

CONTAINERS With Tri Ferrule Clamped Lids



The Sampling Systems range of containers with tri-ferrule fittings are a very popular range for pharmaceutical, chemical and food industries. The high quality finish and 316L stainless steel construction make them ideal for most applications.

The tri ferrule lid profile means they have a robust lid system that also has the advantage that it can be clamped to other tri clamp systems. This gives a dust tight connection system.

The containers can also be electro-polished as an option.

Stainless Containers (50mm Top Diameter)

New sizes



The A836 range are a popular selection of containers. Ideal for storing powders and liquids.

The 2" tri ferrule style lid is a popular feature as it allows it to be clamped to anything with the same profile.

The robust clamped lid gives a powder and water tight fit.

- Multi purpose containers
- Robust construction
- Crevice free interior
- Standard 2" lid (Tri-ferrule style BS 4825-3)
- All welds ground and polished
- Complete with lid, silicone (FDA compliant) and clampband
- 316L stainless steel body and lid.



Part No.	Nominal Volume	Body Diameter	Height	Material
A836-250	250ml	83mm	103mm	316L stainless steel
A836-500	500ml	83mm	153mm	316L stainless steel
A836-1000	1000ml	102mm	183mm	316L stainless steel

316L Stainless PharmaBottles®

Stainless PharmaBottles® are ideal for use with powders and liquids. Each container has a high polish finish and a watertight screw on lid.

Stainless PharmaBottles® are supplied with an FDA acceptable silicone gasket in the lid.

- Multi purpose containers
- 316L stainless steel body and lid
- Robust construction
- Crevice free interior
- All welds ground and polished
- Complete with screw on lid
- Silicone (FDA acceptable) gasket in the lid



Part No.	Nominal Volume	Internal Neck Diameter	Height	Stainless Steel
A846-500	500ml	48mm	154mm	316L
A846-1000	1000ml	48mm	178mm	316L

See page 145 for stainless bottles with clamp top lids



Stainless Containers (100mm Top Diameter)

Our range of Stainless Containers is ideal for use with powders and liquids. The high quality crevice free finish makes these containers ideal for the most demanding of applications.

Available from stock in a wide range of sizes.

- Multi purpose containers
- Robust construction
- Crevice free interior
- Standard 4" lid (Tri-ferrule style BS 4825-3)
- All welds ground and polished
- Complete with lid, silicone (FDA compliant) and clampband
- 316L stainless steel body and lid.



Robust lid is quick and easy to remove

Lid, clamp and seal included in price.



Part No.	Nominal Volume	Body Diameter	Height	Material
A416-1	1 Litre	104mm	152mm	316L stainless steel
A416-2	2 Litres	104mm	227mm	316L stainless steel
A416-5	5 Litres	164mm	316mm	316L stainless steel
A416-8	8 Litres	212mm	283mm	316L stainless steel
A416-10	10 Litres	215mm	364mm	316L stainless steel
A416-15	15 Litres	275mm	360mm	316L stainless steel
A416-20	20 Litres	275mm	440mm	316L stainless steel
A416-30	30 Litres	303mm	602mm	316L stainless steel

Clamp Containers



- Multi purpose containers
- 316L stainless steel
- Crevice free interior
- Supplied with lid, clamp and silicone seal (FDA acceptable grade)
- Wide 4" (100mm) diameter tri-clamp lid BS 4825-3
- Satin finish
- Side handles (excluding 1 litre size)
- Neck has a 60° angle to promote powder discharge



Part No.	Nominal Volume	Diameter	Height	Side Handles	Material
A566-01	1 litres	133mm	109mm	No	316L stainless steel
A566-02	2 litres	130mm	185mm	Yes	316L stainless steel
A566-05	5 litres	180mm	262mm	Yes	316L stainless steel
A566-10	10 litres	210mm	366mm	Yes	316L stainless steel
A566-20	20 litres	303mm	463mm	Yes	316L stainless steel
A566-25	25 litres	303mm	535mm	Yes	316L stainless steel

Latest Technology

With over 1 million parts in stock we use the latest technology to control stock.

Over 95% of the range is available from stock for fast delivery worldwide.

We can deliver to most parts of the world in 2 - 3 days with Europe and North America being a next day service (if the order is received by 1.30pm GMT).



Containers with GL45 Threads

Our range of GL45 containers have the advantage that the lid can be fully removed for full cleaning. The lid comes with a built in adapter so they will mate with standard GL45 threads.

The containers are available in a variety of sizes and come as a standard with a highly polished finish.



- Multi purpose containers
- Heavy duty construction
- Crevice free interior
- 316L stainless steel construction
- Lid can be completely removed for full cleaning

External GL45 Thread (with screw on Cap and silicone seal)



Part No.	Nominal Volume	Body Diameter	Height
A417-1	1 Litre	104mm	182mm
A417-2	2 Litres	104mm	257mm
A417-5	5 Litres	164mm	346mm
A417-8	8 Litres	212mm	313mm
A417-10	10 Litres	215mm	394mm
A417-15	15 Litres	275mm	360mm
A417-20	20 Litres	275mm	470mm



Internal GL45 Thread (not supplied with a Cap)



Part No.	Nominal Volume	Body Diameter	Height
A418-1	1 Litre	104mm	182mm
A418-2	2 Litres	104mm	257mm
A418-5	5 Litres	164mm	346mm
A418-8	8 Litres	212mm	313mm
A418-10	10 Litres	215mm	394mm
A418-15	15 Litres	275mm	360mm
A418-20	20 Litres	275mm	470mm



Mini-Drums

- Multi purpose containers
- Crevice free interior
- Neat recessed fitting lid
- Complete with a swing carrying handle



Toggle Clamps

To secure the lid we recommend the use of toggle clamps

Use 3 toggle clamps per Mini-Drum



O-Ring Seals

- Silicone seal
- FDA grade
- Prices on request

O-rings are also available in Viton and Nitrile - ask for details

Mini-Drums Without Toggle Clamps



Nominal Volume	Height	Diameter	304 stainless steel	316L stainless steel
			Part No.	Part No.
1 litre	155mm	100mm	A434-1	A446-1
2 litres	175mm	130mm	A434-2	A446-2
3 litres	185mm	155mm	A434-3	A446-3
5 litres	240mm	175mm	A434-5	A446-5
6 litres	280mm	175mm	A434-6	A446-6
8 litres	285mm	200mm	A434-8	A446-8
10 litres	295mm	220mm	A434-10	A446-10
12.5 litres	285mm	237mm	A434-12	A446-12
15 litres	285mm	267mm	A434-15	A446-15

Mini-Drums With Toggle Clamps and Silicone Seal



Nominal Volume	Height	Diameter	304 stainless steel	316L stainless steel
			Part No.	Part No.
1 litre	155mm	100mm	A624-1	A626-1
2 litres	175mm	130mm	A624-2	A626-2
3 litres	185mm	155mm	A624-3	A626-3
5 litres	240mm	175mm	A624-5	A626-5
6 litres	280mm	175mm	A624-6	A626-6
8 litres	285mm	200mm	A624-8	A626-8
10 litres	295mm	220mm	A624-10	A626-10
12.5 litres	285mm	237mm	A624-12	A626-12
15 litres	285mm	267mm	A624-15	A626-15



Toggle Drums



The Sampling Systems range of heavy duty toggle drums are ideal for storage and handling of powders and granules. As standard they come with a fully welded handle, silicone seal (FDA grade) and lid. The lid is secured by using the pull down latches (toggle clamps). These drums are manufactured from high grade 316L stainless steel and have a crevice free interior which makes them suitable for hygienic applications.

The toggle drums have a high quality, polished finish which enables complete and thorough cleaning. Large stocks are kept

- Multi purpose open top drums
- Heavy duty construction
- Crevice free interior
- 316L stainless steel body and lid
- Silicone gasket (food grade, FDA acceptable)
- Lid can be completely removed for full cleaning



Part No.	Nominal Volume	Number of Toggles	Internal Diameter	Nominal Height	Material (Body & Lid)
A926-2	2 Litres	2	140mm	160mm	316L stainless steel
A926-5	5 Litres	4	196mm	200mm	316L stainless steel
A926-8	8 Litres	4	196mm	300mm	316L stainless steel
A926-10	10 Litres	4	230mm	270mm	316L stainless steel
A926-15	15 Litres	4	230mm	380mm	316L stainless steel
A926-20	20 Litres	4	300mm	300mm	316L stainless steel
A926-25	25 Litres	4	300mm	380mm	316L stainless steel
A926-30	30 Litres	4	300mm	450mm	316L stainless steel
A926-50	50 Litres	4	395mm	430mm	316L stainless steel
A926-100	100 Litres	6	470mm	610mm	316L stainless steel
A926-200	200 Litres	6	570mm	800mm	316L stainless steel
A926-300	300 Litres	6	710mm	800mm	316L stainless steel

Storage Containers

- Multi purpose containers
- Light duty construction
- Crevice free interior
- Two sturdy handles
- Close fitting recessed lid with handle
- Flat bottom with chime ring to give added protection
- Toggle Clamps and seals are optional extras



Toggle Clamps

Toggle Clamps are used to securely hold the lid. For 20 to 100L containers use 4 toggle clamps



Storage Containers Without Toggle Clamps



Nominal Volume	Height	Diameter	304 stainless steel	316L stainless steel
			Part No.	Part No.
20 Litres	390mm	265mm	A454-20	A466-20
25 Litres	390mm	300mm	A454-25	A466-25
30 Litres	455mm	300mm	A454-30	A466-30
50 Litres	560mm	350mm	A454-50	A466-50
75 Litres	625mm	400mm	A454-75	A466-75
100 Litres	675mm	445mm	A454-100	A466-100

Storage Containers With Toggle Clamps and Silicone Seal



Nominal Volume	Height	Diameter	304 stainless steel	316L stainless steel
			Part No.	Part No.
20 Litres	390mm	265mm	A694-20	A696-20
25 Litres	390mm	300mm	A694-25	A696-25
30 Litres	455mm	300mm	A694-30	A696-30
50 Litres	560mm	350mm	A694-50	A696-50
75 Litres	625mm	400mm	A694-75	A696-75
100 Litres	675mm	445mm	A694-100	A696-100

New sizes

Stainless Storage Drums - 316L ss



Stainless Storage Drums are a new addition to our range. These drums have a very high quality finish and are supplied with sturdy side handles, lid, gasket and clampband.

Stainless Storage Drums are fully opening and so are ideal when working with powders and granules.

The robust, hygienic design means they are suitable for hygienic applications.

- Open top pharmaceutical and chemical grade drums with lids
- From 5L to 200L (larger sizes on request)
- High quality, heavy duty construction
- Product contact parts 316L stainless steel
- Crevice free interior
- Lid secured with clampband (304 stainless steel)
- Lid gasket - FDA acceptable silicone rubber
- Hygienic top rim
- Supplied with side handles
- Fully welded GMP correct construction



Part No.	Nominal Volume	Internal Diameter	Nominal Height	Material (Body & Lid)	Lid Gasket
A126-05	5 Litres	196mm	200mm	316L stainless steel	Silicone - FDA acceptable
A126-10	10 Litres	223mm	280mm	316L stainless steel	Silicone - FDA acceptable
A126-15	15 Litres	230mm	380mm	316L stainless steel	Silicone - FDA acceptable
A126-20	20 Litres	298mm	300mm	316L stainless steel	Silicone - FDA acceptable
A126-25	25 Litres	298mm	379mm	316L stainless steel	Silicone - FDA acceptable
A126-30	30 Litres	298mm	450mm	316L stainless steel	Silicone - FDA acceptable
A126-50	50 Litres	393mm	435mm	316L stainless steel	Silicone - FDA acceptable
A126-75	75 Litres	393mm	630mm	316L stainless steel	Silicone - FDA acceptable
A126-100	100 Litres	470mm	610mm	316L stainless steel	Silicone - FDA acceptable
A126-150	150 Litres	570mm	612mm	316L stainless steel	Silicone - FDA acceptable
A126-200	200 Litres	570mm	800mm	316L stainless steel	Silicone - FDA acceptable

New

Container with Ferrule



These containers are ideal for use with liquids. A hygienic stainless steel drum is fitted with a 1" ferrule (BS4825-3). Containers with Ferrules are the perfect vessel for use in laboratories, production and general work.

The valve (tap) can be clamped on to the ferrule and then be used to empty the container in a controlled manner.

- Manufactured from 316L stainless steel
- Polished
- Robust Construction
- Fitted with a 1" tri ferrule (BS4825-3). Tap can be easily clamped to the container
- Available from stock. Fast delivery worldwide

Note: The tap and accessories are sold separately



A range of optional accessories is available for the containers



15L Container (A196-15) with optional Butterfly Valve and 90° Bend

Bottles & Containers

Container With 1" Ferrule



Part No.	Diameter	Height	Material
A196-05	196mm	200mm	316L ss
A196-10	230mm	270mm	316L ss
A196-15	230mm	380mm	316L ss
A196-20	300mm	300mm	316L ss
A196-25	300mm	380mm	316L ss
A196-30	300mm	450mm	316L ss
A196-50	394mm	431mm	316L ss
A196-75	394mm	630mm	316L ss
A196-100	470mm	610mm	316L ss
A196-150	570mm	610mm	316L ss
A196-200	570mm	800mm	316L ss

Popular Accessories

Part No.	Description
A136-10S	1" Butterfly Valve (316L) with silicone seal
A136-10A	1" Butterfly Valve (316L) with EPDM seal
A136-10B	90° Bend (316L)
A136-10C	Clamp
A136-10E	Spare EPDM seal
A136-10F	Ferrule
A136-10SIL	Spare silicone seal

Trolley

Our stainless steel drums trolleys are ideal for moving equipment around the factory.

- 304 stainless steel frame
- Includes 4 castors (2 lockable)
- Available from stock for fast delivery

Part No.	Max Diameter Drum	Deck Height
A384-320	320mm	135mm
A384-420	420mm	135mm
A384-500	500mm	135mm
A384-600	600mm	135mm
A384-740	740mm	160mm



New



Accessories



Jumbo PharmaScoop with Ergonomic Handle



Our Best Selling PharmaScoop range has been extended with the new jumbo scoops with an additional top handle. This is the perfect scoop when handling large amounts of powder.

The additional handle means the scoop is much easier to handle and use when full of powder. The body also has a rounded back which means it is now even easier to clean

All the welds are ground and polished in the body of the scoop to ensure there are no crevices, in line

- 316L stainless steel
- Robust Construction
- Available from stock. Fast delivery worldwide
- Polished finish

Accessories

Fully Welded

The scoop is fully welded with all the critical welds polished smooth

Top Handle

Gives extra stability when scooping large amounts

Main Handle

Smooth and fully welded to the body

Robust Construction

Made from 1.2mm thick, 316L stainless steel



Radius

Smooth rounded back makes cleaning and operation easier

Polish

High quality polish all over



Part No.	Length (mm)	Diameter (mm)	Overall Length	Material
A776-3000	270mm	150mm	420mm	316L stainless
A776-5000	350mm	200mm	500mm	316L stainless

PharmaScoops®



PharmaScoops are high quality stainless steel scoops. They are ideal for dispensing and for sampling.

- High quality scoops
- Heavy duty construction
- 316L stainless steel
- Crevice free
- Satin finish
- Rounded corners for easy cleaning
- GMP correct



PharmaScoops are a worldwide best seller in the pharmaceutical, food and chemical industries.



Part No.	Nominal Capacity	Body Diameter	Body Length	Overall Length	Material
A316-10	10ml	25mm	45mm	75mm	316L ss
A316-50	50ml	38mm	70mm	110mm	316L ss
A316-100	100ml	50mm	100mm	180mm	316L ss
A316-250	250ml	75mm	120mm	235mm	316L ss
A316-500	500ml	95mm	140mm	240mm	316L ss
A316-750	750ml	95mm	210mm	330mm	316L ss
A316-1000	1000ml	110mm	235mm	340mm	316L ss
A316-1250	1250ml	125mm	195mm	305mm	316L ss
A316-1700	1700ml	135mm	230mm	355mm	316L ss
A316-2500	2500ml	185mm	215mm	320mm	316L ss
A316-5000	5000ml	220mm	220mm	355mm	316L ss

Scorpion PharmaScoops®



- Heavy duty construction
- 316L stainless steel
- Hygienic crevice free construction
- Satin finish
- Rounded corners for easy cleaning



Part No.	Nominal Capacity	Body Width	Body Length	Overall Height
A346-1500	1500ml	155mm	260mm	130mm
A346-2000	2000ml	165mm	300mm	150mm

Long Handled PharmaScoops®



- Extra Long handle
- Crevice free
- 316L stainless steel construction
- Rounded corners for easy cleaning
- GMP correct



Part No.	Nominal Capacity	Body Diameter	Body Length	Handle Length
A396-1000	1000ml	110mm	235mm	600mm

Weighing PharmaScoops®



- Free-standing scoop, ideal for use with weighing scales
- 316L stainless steel
- Rounded corners
- Crevice free construction
- Satin finish
- Robust handle



Part No.	Nominal Capacity	Maximum Width	Body Length	Overall Length
A376-500	500ml	110mm	205mm	320mm

Square PharmaScoops®



- Heavy duty construction
- Made from 316L stainless steel
- Crevice free
- Satin finish
- Rounded corners for easy cleaning
- GMP correct



Part No.	Nominal Capacity	Width	Body Length	Overall Length
A366-1	1500ml	160mm	190mm	315mm
A366-11	1500ml	160mm	190mm	315mm

A366-1 All 316L stainless steel
 A366-11 316L stainless steel Body and 304 stainless steel Handle

Open PharmaScoops®



Open PharmaScoops are a popular alternative to our best selling PharmaScoops (page 155). Open PharmaScoops are designed to be easy to clean due to their crevice free design. They have a broad ergonomic handle which makes them comfortable to use even when wearing gloves.

Huge stocks for fast worldwide delivery.

- Heavy duty construction
- 316L stainless steel
- Crevice free
- Satin finish
- Rounded corners for easy cleaning
- GMP correct



Part No.	Nominal Capacity	Width	Body Length	Overall Length	Material
A336-250	250ml	100mm	150mm	270mm	316L ss
A336-500	500ml	125mm	190mm	320mm	316L ss
A336-750	750ml	110mm	235mm	350mm	316L ss
A336-1000	1000ml	125mm	235mm	360mm	316L ss
A336-1500	1500ml	155mm	255mm	365mm	316L ss
A336-2000	2000ml	145mm	310mm	430mm	316L ss
A336-4000	4000ml	185mm	275mm	400mm	316L ss

SteriWare PharmaScoops®



SteriWare PharmaScoops are high quality, single use, disposable plastic scoops. All SteriWare PharmaScoops are manufactured and packed in a cleanroom. They are widely used in the pharmaceutical and food industries all over the world.

SteriWare PharmaScoops are ideal for use with potent drugs as well as highly coloured or perfumed products.

- Manufactured and packed in a medical cleanroom to ensure cleanliness
- Individually wrapped
- Made from tough, virgin PS, HDPE or PP (FDA acceptable, EU 10/2011 and EC 1935/2004)
- Available non-sterile or pre-sterilised (validated procedure using gamma irradiation)
- Available from stock



Part No.	Nominal Capacity	Sterile	Colour	Material	Quantity Per Box
8045A-30	30ml	No	White	PS	100
8045A-30S	30ml	Yes	White	PS	100
8045A-60	60ml	No	White	PS	100
8045A-60S	60ml	Yes	White	PS	100
8045A-125	125ml	No	White	PS	100
8045A-125S	125ml	Yes	White	PS	100
8045A-250	250ml	No	White	PS	100
8045A-250S	250ml	Yes	White	PS	100
8045A-500	500ml	No	White	PS	100
8045A-500S	500ml	Yes	White	PS	100
8045A-1000	1000ml	No	White	PS	100
8045A-1000S	1000ml	Yes	White	PS	100
8045A-2500	2500ml	No	White	PS	60
8045A-2500S	2500ml	Yes	White	PS	60
8045R-60	60ml	No	Red	PS	100
8045R-60S	60ml	Yes	Red	PS	100
8045R-500S	500ml	Yes	Red	PS	100
8045R-1000	1000ml	No	Red	PS	100
8045R-1000S	1000ml	Yes	Red	PS	100
8045R-2500S	2500ml	Yes	Red	PS	60
8045P-500	500ml	No	White	PP	100
8045P-1000	1000ml	No	White	PP	100
8045B-60	60ml	No	Blue	PP	100
8045B-60S	60ml	Yes	Blue	PP	100
8045B-125S	125ml	Yes	Blue	PP	100

For the complete range please see pages 9 - 13

PTFE Scoops



- Crevice free
- PTFE construction (FDA acceptable and USP Class VI)
- Rounded corners for easy cleaning
- GMP correct



Part No.	Nominal Capacity	Body Diameter	Body Length	Overall Length
A333-100	100ml	65mm	95mm	195mm
A333-500	500ml	100mm	140mm	265mm

Industrial Scoops



- Light duty construction
- Stainless steel
- Fully welded construction

Part No.	Nominal Capacity	Body Width	Body Length	Overall Length
A643-100	100ml	60mm	115mm	180mm
A643-200	200ml	75mm	135mm	205mm
A643-300	300ml	90mm	150mm	230mm
A643-500	500ml	110mm	180mm	270mm

Economy Scoops



- Light duty construction
- 304 stainless steel

Important Note - Economy Scoops are not crevice free and are therefore not suitable for GMP applications



Part No.	Nominal Capacity	Diameter	Overall Length
A304-120	120ml	50mm	195mm
A304-450	450ml	75mm	255mm
A304-1000	1000ml	120mm	315mm
A304-1500	1500ml	120mm	345mm
A304-2000	2000ml	150mm	365mm

Ice Scoops



- Perforated to allow excess water to flow away
- 304 stainless steel



Part No.	Nominal Capacity	Body Diameter	Body Length	Overall Length
A314-100	100ml	50mm	100mm	180mm

Scorpion Scoop Eco



- 304 stainless steel
- Satin finish
- Suitable for general, light duty use



Part No.	Nominal Capacity	Body Width	Body Length	Overall Height
A334-1000	1000ml	120mm	230mm	200mm

SteriWare® Ladle

Efficient surface sampling of liquids

The SteriWare Ladle is ideal for the surface sampling of liquids. They can be used straight-from-the-bag; simply unwrap and use.

The one piece moulded design has been specially constructed to go through standard 2" lid bungs which are commonly found on barrels and kegs.

- Moulded & Packed in a Cleanroom
- Individually Bagged
- FDA & EU 10/2011 Conforming Materials
- BSE/TSE Free
- Full Batch Traceability
- Available Sterile (gamma irradiated)
- Available from stock



Part No.	Nominal Volume	Sterile	Material	Colour	Quantity per Box
8053H-50	50ml	No	HDPE	Natural	40
8053H-50S	50ml	Yes	HDPE	Natural	40
8053B-50	50ml	No	PP	Blue	40
8053B-50S	50ml	Yes	PP	Blue	40

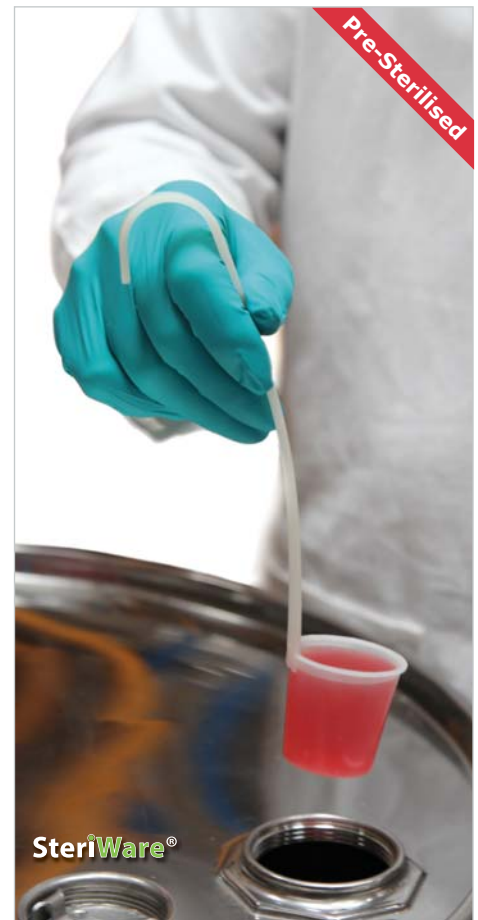

Accessories

Stainless Ladle

- Satin finish
- 304 or 316L stainless steel
- All stainless steel construction
- Crevice free construction



Part No.	Nominal Volume	Stainless Steel	Bowl Diameter	Handle Length
A326-150	150ml	316L	88mm	370mm
A324-50	50ml	304	63mm	275mm
A324-120	120ml	304	82mm	345mm
A324-150	150ml	304	92mm	350mm
A324-200	200ml	304	100mm	365mm



Stainless Dippers

- 316L stainless steel
- Crevice free cup



Part No.	Nominal Volume	Stainless Steel	Cup Diameter	Overall Length
5005A-100	100ml	316L	39mm	600mm
5005B-100	100ml	316L	39mm	1000mm
5005A-250	250ml	316L	64mm	600mm
5005B-250	250ml	316L	64mm	1000mm
5005A-500	500ml	316L	90mm	600mm
5005B-500	500ml	316L	90mm	1000mm



Bailers



- Crevice free
- Satin finish
- Flat cut rim on bowl
- 316L Stainless Steel



Part No.	Nominal Volume	Max. Bowl Diameter	Overall Length
A296-1	1 litre	170mm	285mm
A296-2	2 litre	215mm	340mm
A296-4	4 litre	270mm	415mm

In-Stream Sampler



The In-Stream Sampler is a useful piece of equipment for taking samples from a product that is flowing. Alternatively it can be used to take samples directly from containers or vessels.

The In-Stream Sampler is made from robust 316L stainless steel. It can be used for sampling both powders and liquids.

- Multi purpose sampler
- 316L stainless steel
- Crevice free interior
- Available from stock
- Polished finish



Part No.	Nominal Volume	Internal Diameter	Handle Length
A996-500	500ml	80mm	1000mm



Medicine Cups (Small Volume)



Our medicine cups are ideal for putting small amounts of tablets, granules or powder into. The flat base design means they are ideal for weigh scales.

- 304 stainless steel
- Crevice free
- Polished



Part No.	Nominal Volume	Diameter	Height
A764-30	30ml	50mm	25mm

Pallet Knives and Scrapers



SteriWare Pallet Knife

- Moulded & Packed in a Cleanroom
- Individually Bagged
- FDA, EC 1935/2004 & EU 10/2011 Conforming Materials
- BSE/TSE Free
- Full Batch Traceability
- Available Sterile (gamma irradiated)



Part No.	Blade Length	Blade Width	Overall Length	Sterilised	Material	Quantity per Box
8175H-150	150mm	40mm	260mm	No	HDPE	100
8175H-150S	150mm	40mm	260mm	Yes	HDPE	100
8175H-200	200mm	45mm	300mm	No	HDPE	100
8175H-200S	200mm	45mm	300mm	Yes	HDPE	100

Disposable Scraper

- Moulded & Packed in a Cleanroom
- Individually Bagged
- FDA, EC 1935/2004 & EU 10/2011 Conforming Materials
- BSE/TSE Free
- Full Batch Traceability
- Available Sterile (gamma irradiated)



Part No.	Blade Length	Blade Width	Overall Length	Sterile	Material	Quantity per Box
8785H-75	75mm	75mm	190mm	No	HDPE	100
8785H-75S	75mm	75mm	190mm	Yes	HDPE	100
8785B-75	75mm	75mm	190mm	No	Blue PP	100
8785B-75S	75mm	75mm	190mm	Yes	Blue PP	100
8785H-110	110mm	110mm	225mm	No	HDPE	100
8785H-110S	110mm	110mm	225mm	Yes	HDPE	100

GMP Pallet Knives

- Crevice free, all stainless steel construction
- Satin finish

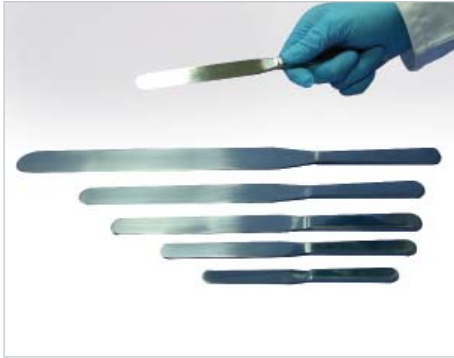

Part No.	Blade Length	Blade Width	Overall Length
A330-100	100mm	25mm	185mm
A330-130	130mm	20mm	225mm
A330-150	150mm	25mm	255mm
A330-200	200mm	32mm	325mm
A330-250	250mm	38mm	380mm
A330-300	300mm	45mm	440mm
A330-350	350mm	50mm	495mm

Pallet Knife with Plastic Handle

- Stainless steel blade with plastic handle
- Satin finish



Part No.	Blade Length	Blade Width	Overall Length
A200-100	100mm	20mm	190mm
A200-200	200mm	30mm	310mm
A200-300	300mm	35mm	415mm

Pallet Knife with Wooden Handle

- Stainless steel blade with wooden handle
- Satin finish



Part No.	Blade Length	Blade Width	Overall Length
A201-100	100mm	20mm	190mm
A201-200	200mm	30mm	310mm
A201-300	300mm	35mm	415mm

Stainless Steel Scrapers

- Crevice free, stainless steel construction
- Satin finish



Part No.	Stainless Steel	Blade Width	Overall Length
A350-75	420S45	75mm	232mm
A350-100	420S45	100mm	277mm
A656-100	316L	100mm	235mm

Funnels Disposable & reusable



Powder Funnels



- 316L stainless steel
- Satin finish
- Tri ferrule fitting at spout base (BS4825-3)



Part No.	Stainless Steel	Top Diameter	Tri Ferrule Size	Height
A716-100	316L	100mm	1.5"	107mm
A716-200	316L	200mm	1.5"	232mm
A716-300	316L	300mm	2"	310mm

Disposable Powder Funnel



The Sampling Systems Powder Funnel is ideal for transferring powders. Available both sterile and non sterile. Made from chemically resistant food grade plastic.

- Individually bagged
- FDA and EC conforming material
- Available from stock for fast delivery worldwide



Part No.	Top Diameter	Spout Diameter	Sterile	Material	Quantity per Box
8111H-200	200mm	40mm	No	HDPE	10
8111H-200S	200mm	40mm	Yes	HDPE	10
8111P-350	350mm	50mm	No	PP	TBA
8111P-350S	350mm	50mm	Yes	PP	TBA

Powder Funnel



- Ideal for loading powder into drums, containers or kegs
- Crevice Free

Part No.	Top Diameter	Outlet Diameter	Material
8023P-100	100mm	26mm	PP
8023P-150	150mm	30mm	PP
8023H-200	200mm	40mm	HDPE
8023H-250	250mm	50mm	HDPE
8023P-350	350mm	50mm	PP

SteriWare Liquid Funnel

- Moulded & Packed in a Cleanroom
- Individually Bagged
- FDA & EU 10/2011 Conforming Materials
- BSE/TSE Free
- Full Batch Traceability
- Available Sterile (gamma irradiated)



Part No.	Top Diameter	Spout Diameter	Colour	Sterile	Material	Quantity per Box
8370H-100	100mm	10mm	Natural	No	HDPE	100
8370H-100S	100mm	10mm	Natural	Yes	HDPE	100
8370B-100	100mm	10mm	Blue	No	PP	50
8370B-100S	100mm	10mm	Blue	Yes	PP	50
8370H-200	200mm	15mm	Natural	No	HDPE	20
8370H-200S	200mm	15mm	Natural	Yes	HDPE	10

Liquid Funnels

- 304 stainless steel
- Satin finish
- Fluted spout to aid product discharge



Part No.	Top Diameter	Spout Diameter	Height
A244-50	60mm	14mm	65mm
A244-100	100mm	12mm	120mm
A244-120	120mm	12mm	140mm
A244-150	150mm	12mm	160mm
A244-200	200mm	20mm	200mm
A244-250	250mm	20mm	325mm
A244-310	310mm	20mm	325mm



Liquid Funnel

- PP construction
- Crevice Free
- Re-usable



Part No.	Top Diameter	Outlet Diameter
8022P-100	100mm	10mm
8022P-200	200mm	25mm



PTFE Funnel

- Crevice free interior
- Heavy wall construction



Part No.	Top Diameter	Discharge Diameter	Height
A105-30	30mm	8mm	50mm
A105-50	50mm	10mm	85mm
A105-70	70mm	12mm	110mm
A105-100	100mm	14mm	170mm
A105-150	150mm	16mm	220mm



Funnel With Strainer



Our Funnels with strainer are ideal for removing large particles.

- 304 stainless steel
- Polished



Part No.	Top Diameter	Height	Hole Size	Material
A904-165	165mm	165mm	4mm	304 ss

Sieving Tool



- Ideal for pushing powders through mesh screens
- 316L stainless steel
- Rounded corners
- Crevice free construction
- Satin finish



Part No.	Disc Diameter	Handle Length	Material
A516-120	120mm	160mm	316L ss

Earthing Lugs



- Extra cost option for any stainless steel item such as a scoop, sampler or container etc...
- Provides a convenient connection point for earthing (grounding) wires
- Ideal when working with flammable solvents or in ATEX rated environments
- Earthing lugs can be welded to almost any stainless steel device



Part No.	Description
LUG-1	Earthing Lug - 316L stainless steel

Bowls



- Crevice free design
- Polished finish
- Range of sizes
- 304 Stainless Steel



Part No.	Nominal Volume	Diameter	Height	Material
A534-1000	1000ml	170mm	85mm	304 ss
A534-2000	2000ml	220mm	110mm	304 ss
A534-4000	4000ml	270mm	130mm	304 ss



Heavy Duty Buckets (316L stainless Steel)



Stainless Buckets are made from heavy gauge 316L stainless steel and so are very durable.

- Made from 316L stainless steel
- Crevice free interior
- Swing handle
- Flat base
- Not graduated
- Lids sold separately



Part No.	Nominal Volume	Max Diameter	Height	Material
A586-10	10 litres	300mm	233mm	316L ss
A586-12	12 litres	310mm	262mm	316L ss
A586-15	15 litres	330mm	305mm	316L ss
A586-10L	Lid for 10L Bucket (A586-10) - 316L ss			
A586-12L	Lid for 12L Bucket (A586-12) - 316L ss			
A586-15L	Lid for 15L Bucket (A586-15) - 316L ss			

Buckets



- Crevice free interior
- Graduated
- Supplied with skirt band
- Robust design
- 304 stainless steel
- Lids sold separately (Lids not available for 6L bucket)



Bucket Part No.	Nominal Volume	Top Diameter	Height	Material
A264-6	6 litres	280mm	190mm	304 ss
A264-10	10 litres	300mm	295mm	304 ss
A264-12	12.5 litres	330mm	315mm	304 ss
A264-15	15 litres	350mm	360mm	304 ss
A264-10L	Lid for 10L Bucket (A264-10) -304ss			
A264-12L	Lid for 12L Bucket (A264-12) -304ss			
A264-15L	Lid for 15L Bucket (A264-15) -304ss			

Buckets with Spouts (316L Stainless Steel)



- Bucket with pouring spout
- Made from 316L stainless steel
- Crevice free interior
- Not graduated
- Swing handle
- Supplied with skirt band
- Drop on lid. Covers the spout completely. Lids sold separately



Bucket Part No.	Nominal Volume	Overall Diameter	Nominal Height	Material
A686-15	15 litres	310mm	333mm	316L ss
A686-20	20 litres	330mm	387mm	316L ss
A686-15L	Lid for 15L Bucket with Spout (A686-15) - 316L ss			
A686-20L	Lid for 20L Bucket with Spout (A686-20) - 316L ss			

Accessories

Spoons Disposable & reusable



Accessories

SteriWare Sample Spoons

Ideal for dispensing and sampling small quantities

- Moulded & Packed in a Cleanroom
- Individually Bagged, 100 per Box
- Made from FDA & EU 10/2011 Conforming Materials
- BSE/TSE Free
- Full Batch Traceability
- Available Sterile (gamma irradiated)

See pages 16-17 for the full range

Part No.	Nominal Volume	Colour	Sterile
8088A-03	3ml	White	No
8088A-03S	3ml	White	Yes
8088A-10	10ml	White	No
8088A-10S	10ml	White	Yes
8088B-10	10ml	Blue	No
8088B-10S	10ml	Blue	Yes
8088R-10S	10ml	Red	Yes



SteriWare Micro-Spatulas

Ideal for handling small quantities of powders & granules

- Moulded & Packed in a Cleanroom
- Individually Bagged, 100 per Box
- Made from FDA & EU 10/2011 Conforming Materials
- BSE/TSE Free
- Full Batch Traceability
- Available Sterile (gamma irradiated)

See page 21 for the full range

Part No.	Nominal Volume	Sterile	Blade Width x Length
8015V-170	0.3ml	No	4 x 40mm
8015V-170S	0.3ml	Yes	4 x 40mm
8015N-170	0.5ml	No	6 x 40mm
8015N-170S	0.5ml	Yes	6 x 40mm
8015A-170	2ml	No	13 x 40mm
8015A-170S	2ml	Yes	13 x 40mm



Stainless Spoons 304ss

- 304 stainless steel construction
- Crevice free
- Bowl & flat ends
- Satin finish



Part No.	Nominal Bowl Volume	Nominal Overall Length	Material
A504-1	2ml	155mm	304 ss
A504-2	10ml	210mm	304 ss
A504-3	2ml	300mm	304 ss
A504-4	10ml	305mm	304 ss
A504-5	10ml	500mm	304 ss

Stainless Spoons 316L ss



- 316L stainless steel construction
- Crevice free
- Bowl & flat ends
- Satin finish

Part No.	Nominal Bowl Volume	Nominal Overall Length	Material
A506-300	10ml	300mm	316L ss
A506-600	10ml	600mm	316L ss
A506-1000	10ml	1000mm	316L ss

Micro-Spatulas

- Stainless Steel
- Range of sizes
- Crevice free
- Bright polish finish



* A100-20 and A106-20



Part No.	Material	Blade Width	Blade Length	Overall Length
A100-1	304	9mm	50mm	210mm
A100-2	304	5mm	45mm	210mm
A100-3	304	2.5mm	35mm	150mm
*A100-20	304	12mm	40mm	175mm
*A106-20	316L	12mm	40mm	175mm

Volumetric Spoons

- Crevice free
- Satin finish
- Supplied as a set
- Each spoon is engraved with volume



Part No.	Stainless Steel	Volume	Bowl Diameter	Overall Length
A335-1	304	1.25ml 5ml 15ml 100ml	23mm 33mm 46mm 79mm	107mm 112mm 118mm 127mm

Note: Volumetric Spoons are not certified measuring devices

JUGS Disposable & reusable



Accessories

SteriWare Jugs (Graduated)

Our graduated measuring beakers are moulded and packed in a Cleanroom. These ergonomically designed jugs can be used straight from the bag.

- Graduation marks
- Individually Bagged
- FDA, EC 1935/2004 & EU 10/2011 conforming materials
- BSE/TSE Free
- Full Batch Traceability
- Available Sterile (gamma irradiated)
- Cleanroom produced and packed



Part No.	Nominal Volume	Sterile	Top Diameter	Height	Material	Quantity per Box
8432P-500	500ml	No	90mm	130mm	PP	35
8432P-500S	500ml	Yes	90mm	130mm	PP	35
8432P-1000	1000ml	No	120mm	170mm	PP	18
8432P-1000S	1000ml	Yes	120mm	170mm	PP	18

Disposable Jugs (Non Graduated)

Disposable Jugs have a wide base which makes them very stable. The handle is rounded to make it comfortable to hold.

These jugs are non-graduated.

- Individually Bagged
- FDA & EU 10/2011 Conforming Materials
- BSE/TSE Free
- Full Batch Traceability
- Available Sterile (gamma irradiated)



Part No.	Nominal Volume	Sterile	Diameter	Height	Material	Quantity per Box
8049H-2000	2000ml	No	129mm	152mm	HDPE	20
8049H-2000S	2000ml	Yes	129mm	152mm	HDPE	16

Stainless Jugs



- Straight sided jugs with side handles
- 304 or 316L stainless steel construction
- Most sizes are graduated



Part No.	Stainless Steel	Nominal Volume	Graduated	Top Diameter	Height
A204-500	304	500ml	Yes	75mm	135mm
A204-1000	304	1000ml	Yes	100mm	135mm
A204-2000	304	2000ml	Yes	135mm	170mm
A204-3000	304	3000ml	No	120mm	230mm
A204-5000	304	5000ml	No	140mm	265mm
A206-500	316L	500ml	Yes	75mm	135mm
A206-1000	316L	1000ml	Yes	100mm	135mm
A206-2000	316L	2000ml	Yes	135mm	170mm

Jugs 316L ss



- Crevice free interior
- Polished finish
- 316L stainless steel



Part No.	Stainless Steel	Nominal Volume	Graduated	Top Diameter	Height
A186-500	316L	500ml	No	105mm	100mm
A186-1000	316L	1000ml	No	120mm	140mm
A186-2000	316L	2000ml	Yes	160mm	175mm

Conical Jugs



- Made from 304 stainless steel
- Crevice free design
- Polished finish
- Graduated



Part No.	Stainless Steel	Nominal Volume	Graduated	Top Diameter	Height
A154-500	304	500ml	Yes	115mm	115mm
A154-1000	304	1000ml	Yes	150mm	140mm
A154-2000	304	2000ml	Yes	171mm	200mm

Instrument Trays



The Sampling Systems range of stainless steel trays are ideal for carrying tools etc.

- Range of sizes
- Available from stock
- Crevice free design
- High quality polished finish



Part No.	Dimensions (L x W x H)	Material
A674-215	215 x 160 x 18mm	304 Stainless
A674-295	295 x 197 x 18mm	304 Stainless
A674-395	395 x 275 x 11mm	304 Stainless
A674-490	490 x 320 x 15mm	304 Stainless

Stainless Trays - General Purpose



The general purpose range of trays are ideal for everything from mixing formulations to carrying waste.

- Range of sizes
- Available from stock
- Crevice free design
- High quality polished finish
- Durable



Part No.	Dimensions (L x W x H)	Material
A684-223	223 x 155 x 43mm	304 Stainless
A684-240	240 x 160 x 50mm	304 Stainless
A684-310	310 x 197 x 47mm	304 Stainless
A684-340	340 x 210 x 62mm	304 Stainless

Tablet Counting Triangle

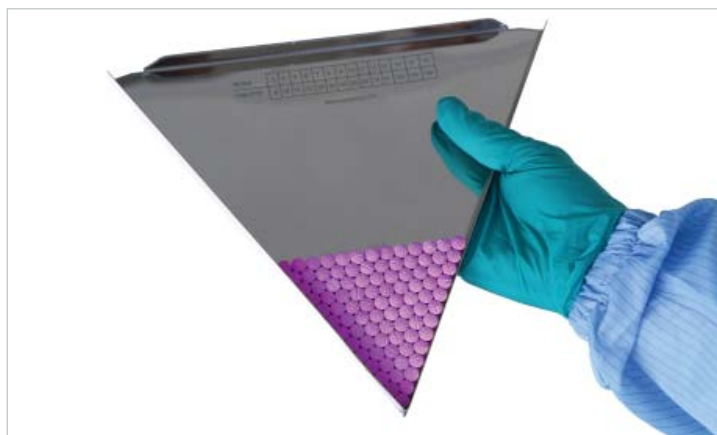

- Quick and easy way to count round tablets
- Suitable for all sizes of round tablets
- 316L stainless steel
- Satin finish
- Easily used by right handed and left handed people
- Etched with a guide to show the number of tablets in the tray



Part No.	Side Length	Material
A356-275	275mm	316L ss

Shallow Tray



- All purpose shallow tray
- Crevice free
- 304 stainless steel construction
- Satin finish



Part No.	Stainless Steel	Length	Width	Depth
A224-220	304	220mm	150mm	10mm

Deep Trays



- Multi-purpose deep tray
- Crevice free
- 304 or 316L stainless steel construction
- Satin finish



Part No.	Stainless Steel	Length	Width	Depth
A234-220	304	355mm	250mm	55mm
A236-250	316L	252mm	177mm	50mm

SteriWare Tray

The disposable Tray is ideal for hygienic applications within hospitals and in the manufacture of pharmaceutical products.

- Moulded & Packed in a Cleanroom
- Individually Bagged
- FDA, EC 1935/2004 & EU 10/2011 Conforming Materials
- BSE/TSE Free
- Full Batch Traceability
- Available Sterile (gamma irradiated)



Part No.	Dimensions (L x W x H)	Nominal Volume	Sterile	Material	Quantity per Box
8081P-3000	310 x 265 x 55mm	3000ml	No	PP	40
8081P-3000S	310 x 265 x 55mm	3000ml	Yes	PP	40

Stirring Paddles

- 316L stainless steel
- Crevice free construction
- Satin finish
- Now available with holes for improved stirring



Part No.	Overall Length	Blade Width	Blade Length	Blade Type
A344-1000	1000mm	125mm	240mm	Plain
A344-1500	1500mm	150mm	300mm	Plain
A916-1000	1000mm	125mm	240mm	With Holes
A916-1500	1500mm	150mm	300mm	With Holes

Stirrer

- Manufactured from chemically resistant PP
- Hygienic one piece design



Part No.	Blade Length	Blade Width	Overall Length
8331P-1	290mm	133mm	1200mm

Paddle

- Manufactured from chemically resistant PP
- Hygienic one piece design



Part No.	Blade Length	Blade Width	Overall Length
8332P-1	290mm	133mm	1200mm

Shovel

- Robust yet lightweight
- Manufactured from chemically resistant PP
- Hygienic one piece design



Part No.	Head Width	Head Length	Overall Length
8228P-27	270mm	330mm	1100mm
8228P-33	330mm	370mm	1100mm

Bailer

- PP Construction
- Crevice free design
- Smooth finish



Part No.	Nominal Volume	Diameter
8333P-2	2 litres	220mm

Tweezers (Forceps)

- Polished finish
- Range of sizes
- 304 stainless steel



Part No.	Stainless Steel	Length	Blade Length
A394-100	304	100mm	70mm
A394-200	304	200mm	155mm
A394-300	304	300mm	240mm

Disposable Tweezers (Forceps)

Tweezers with a Unique Dual Action

The new disposable tweezers (forceps) from sampling systems are ideal for picking up items up to 25mm, Its unique design means it can pick up both small and large items. Available pre-sterilised as an option for the more demanding applications

- Individually bagged
- FDA and EC conforming material
- Cleanroom manufacture and packing (ensures cleanliness)
- Available from stock for fast delivery worldwide



Part No.	Length	Width	Sterile	Material	Quantity per Box
8025H-115	115mm	10mm	No	HDPE	100
8025H-115S	115mm	10mm	Yes	HDPE	100

Scissors

- Two pointed blades
- Polished finish
- Range of sizes
- Made from stainless steel



Part No.	Overall Length	Blade Length
A364-150	150mm	45mm
A364-200	200mm	100mm

Rounded Scissors

- One rounded blade and one pointed blade
- Polished finish
- Made from stainless steel



Part No.	Overall Length	Blade Length
A555-150	150mm	70mm

Cleaning Coupons

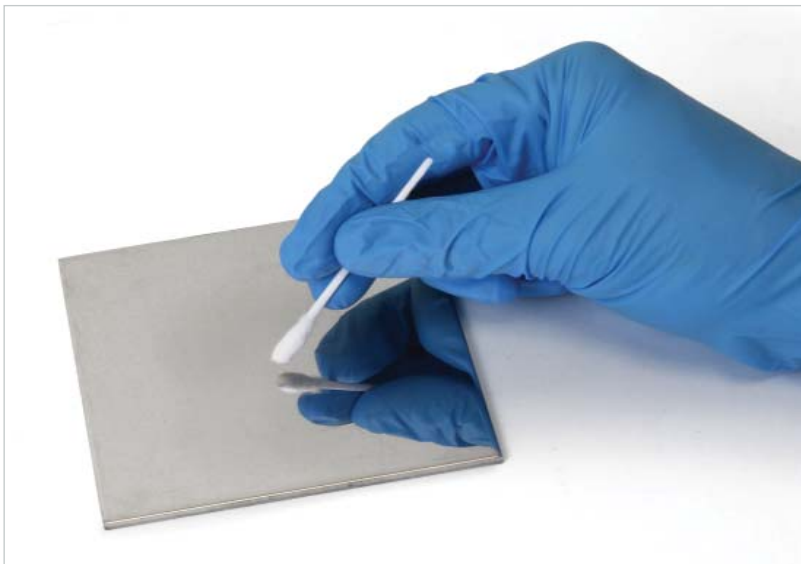

- Test and validate your cleaning regime with our range of Cleaning Coupons
- Available in all popular materials and various sizes
- Custom made coupons available on request

Metal

Part No.	Material	Size
8644AL-50	Aluminium (bright polish)	50 x 50mm
8644AL-100	Aluminium (bright polish)	100 x 100mm
8644S4-50S	304 stainless (satin finish)	50 x 50mm
8644S4-100S	304 stainless (satin finish)	100 x 100mm
8644S4-50B	304 stainless (bright polish)	50 x 50mm
8644S4-100B	304 stainless (bright polish)	100 x 100mm
8644S6-50S	316 stainless (satin finish)	50 x 50mm
8644S6-100S	316 stainless (satin polish)	100 x 100mm
8644S6-50B	316 stainless (bright finish)	50 x 50mm
8644S6-100B	316 stainless (bright polish)	100 x 100mm

Plastic

Part No.	Material	Size
8644H-50	HDPE	50 x 50mm
8644H-100	HDPE	100 x 100mm
8644N-50	Nylon	50 x 50mm
8644N-100	Nylon	100 x 100mm
8644PP-50	PP (polypropylene)	50 x 50mm
8644PP-100	PP (polypropylene)	100 x 100mm
8644PVC-50	PVC	50 x 50mm
8644PVC-100	PVC	100 x 100mm
8644T-50	Teflon (PTFE)	50 x 50mm
8644T-100	Teflon (PTFE)	100 x 100mm

Satin finish is similar to 240 grit (Ra < 1 micron). Bright polish is Ra < 0.2 microns

Thermometer with Stainless probe

Suitable for Liquids and Solids

The Sampling Systems thermometer is a robust, accurate device and is ideal for general laboratory use.

- Hygienic stainless steel probe
- Range: -39.9 to 149.9°C (accurate up to 124.9°C)
- Supplied with traceable certificate of calibration
- Light weight (only 45g)
- Highly accurate
- Housed in high impact ABS plastic case
- Clear display



Part No.	Length	Probe Diameter	Material	Battery Life	Sensor Type
8702A-1	246mm	3mm	Stainless steel with ABS case	3000 Hours	Thermistor

Titrating Burette Automatic

Precise Dosing



The Sampling Systems range of automatic burettes are ideal when dosing small amounts of liquids.

- Highly accurate. Complies with category B DIN ISO 385
- As standard fitted with the micro-doser for highly accurate work as well as a general discharge button
- Shatter-proof
- Material contact parts are manufactured from PE plastic, borosilicate and latex
- Suitable for both left and right handed people
- Highly visible graduations
- Supplied with a sturdy stand



Press button for general discharge



Screw in for accurate discharge

Part No.	Capacity	Precision	Height
8703A-05	5 ml	+/- 0.030 ml	480 mm
8703A-10	10 ml	+/- 0.030 ml	570 mm
8703A-15	15 ml	+/- 0.045 ml	490 mm
8703A-25	25 ml	+/- 0.045 ml	610 mm
8703A-50	50 ml	+/- 0.075 ml	870 mm

Grab-It Swab Holder

- Ideal for holding cloth swabs
- Lightweight aluminium & plastic construction



Part No.	Description
8420A-750	Grab-It 750mm long
8420A-1300	Grab-It 1300mm long



Sampler Rack

Safe storage of Samplers

Our Sampler Rack is ideal for hanging up samplers when they are not being used. Stainless steel and plastic construction. The standard rack can hold up to 5 samplers.

Samplers are attached by a simple push clip design. Comes complete with hole fixings.

Suitable for samplers from 10mm to 35mm diameter and up to 4kg in weight.



Part No.	Description
8820A-01	Sampler Rack - 900mm long - holds up to 5 samplers
8820A-02	Sampler Rack - 500mm long - holds up to 3 samplers



TeleSwab

Telescopic swabbing tool

Taking swabs from high and difficult to reach places has always been a problem. The TeleSwab has an extendable handle which allows operators to quickly and easily take swabs from previously inaccessible places.

Ideal for environmental swabbing and for use with large items of processing equipment.

The sampler comes complete with an extendable handle that can be extended to the correct length for easy swabbing. An adjustable adapter allows the swabs etc. to be angled to meet the contours of the item being sampled.

The PTFE Template tool allows a fixed area to be swabbed.

Note: Make sure that you include the hole dimensions at the time of ordering.

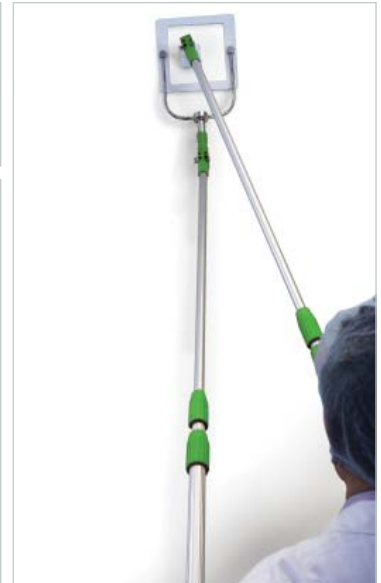

Angle adapter allows end section to be set at the correct angle



What do I need?

Two kits are available, each kit contains:

Kit 1 - Part No. 8011K-01

- 1x Telescopic Pole (8011A-3)
- 1x Angle Adapter (8011A-5)
- 1x Swab Holder (8011A-4B)

Kit 2 - Part No. 8011K-02

- 1x Telescopic Pole (8011A-3)
- 1x Template holder (8011A-6)
- 1 x Swabbing Template (8011A-7) - hole cut to customer's requirements
- 1 x Angle adapter

Part No.	Description
8011K-01	Kit 1 - Extendable TeleSwab Pole with swab holder (Note: swabs are not included)
8011K-02	Kit 2 - Extendable TeleSwab Pole with swabbing template
Spares	
8011A-4B	Universal Swab Holder - 316 stainless steel construction
8011A-5	Adjustable angle adapter to hold Swab Holder - aluminium
8011A-6	Template holder - stainless steel
8011A-7	Swabbing Template - PTFE - hole cut to customer's requirements
8505A-01	Storage Case

Other types of swab holders and accessories are available. Please contact us for details.

Sieve-It Test Sieves

Robust Sieves for particle size analysis

High Quality test sieves for accurate and efficient particle size analysis.

- Woven wire mesh sieves
- Construction: All stainless steel or brass frame and stainless steel mesh
- Range of aperture sizes available (20 microns to 4mm)
- Certificate of Conformity supplied with each sieve
- Other styles of sieve available on request (Perforated Plate Sieves, Microplate Sieves, Grain sieves etc.)
- Test sieves manufactured to every major International standard (inc. ISO, BSI, & ASTM)



200mm Diameter Test Sieves (Woven Wire)

All Stainless Steel		Brass Frame & Stainless Mesh	
Part No.	Aperture	Part No.	Aperture
8700S-01	4mm	8700B-01	4mm
8700S-02	2mm	8700B-02	2mm
8700S-03	1mm	8700B-03	1mm
8700S-04	850 microns	8700B-04	850 microns
8700S-05	710 microns	8700B-05	710 microns
8700S-06	600 microns	8700B-06	600 microns
8700S-07	500 microns	8700B-07	500 microns
8700S-08	425 microns	8700B-08	425 microns
8700S-09	300 microns	8700B-09	300 microns
8700S-10	250 microns	8700B-10	250 microns
8700S-11	180 microns	8700B-11	180 microns
8700S-12	150 microns	8700B-12	150 microns
8700S-13	125 microns	8700B-13	125 microns
8700S-14	106 microns	8700B-14	106 microns
8700S-15	90 microns	8700B-15	90 microns
8700S-16	75 microns	8700B-16	75 microns
8700S-17	53 microns	8700B-17	53 microns
8700S-18	32 microns	8700B-18	32 microns
8700S-19	25 microns	8700B-19	25 microns
8700S-20	20 microns	8700B-20	20 microns

Sieve Height

The standard height for a 200mm diameter sieve is 50mm.

Other diameters and mesh sizes are available.

Please ask for details.

Sieve Receiver 316L

Sieve Receivers collect the product that passes through the sieve stack. They are suitable for use with 200mm diameter sieves.

- Made from 316L stainless steel
- Crevice free interior



Part No.	Diameter	Height	Stainless Steel
A736-3000	200mm	100mm	316L



Certificates & Specifications are all available to download

Our web site now has a special section where the latest certificates of conformity, specification sheets and also general information can be downloaded

For more information please visit: www.sampling.com/certificates_download



Seal-It



The Seal-It Impulse Bag Sealer is a quick, easy and clean way to seal your samplers and equipment in plastic lay flat tubing.

- Ensure clean samplers remain clean until they are required for use.
- Seal used samplers so they do not contaminate clean areas on their way to the wash area
- Ensure the integrity of your samples (samples that are sealed in a bag can not be contaminated or adulterated on their way to the testing laboratory)



Cut the lay-flat tubing to length & seal one end



Place the item to be sealed in the bag



Seal the open end of the bag



Items secured and ready for storage

Part No.	Description
6060A-200	Impulse Bag Sealer - 200mm sealing surface - 230v 50Hz supplied with UK 3 pin plug (Type G)
6060A-300	Impulse Bag Sealer - 300mm sealing surface - 230v 50Hz supplied with UK 3 pin plug (Type G)

Part No.	Description	Material	Width	Length	Rolls per case
6060B-75	Layflat Tubing	Polyethylene	75mm	300m	1
6060B-100	Layflat Tubing	Polyethylene	100mm	335m	1
6060B-150	Layflat Tubing	Polyethylene	150mm	335m	1
6060B-300	Layflat Tubing	Polyethylene	300mm	335m	1

Etch-It™

Crevice Free GMP Marking System



Sampling Systems` Etch-It system is the ideal way to permanently mark both stainless steel and aluminium.

Hygienic, GMP correct, crevice free etchings can be done in seconds.

Etching Masks and Etching Paper

An Etching Mask is required as a template for your text.

Etching Masks can be quickly and easily made using the Etch-It printer. These masks can be used up to two or three times.

1. Make an Etching Mask



Produce your own etching masks quickly and easily. Simply type the text you require and print it straight on to the etching paper. The etching paper is supplied in a special cassette

- Range of font types and sizes
- Quick and easy to use
- Etching paper supplied in an easy to load cassette
- Requires 230v 50Hz electrical supply or 8 x Batteries Size AA (R6) - not supplied
- Supplied with 3 pin UK (Type G) plug

2. Etch



On Line Video

To see how easy it is to use the Etch-It please visit

www.sampling.com/product_channel



1. Plug In the leads



2. Attach Lead on item that is to be etched



3. Place the Etching Mask and apply the etching fluid using the Electrolyte Applicator



4. Clean etching area thoroughly using demineralised water

Part No.	Description
8096A-1	Etch-It Starter Kit containing:
	1 x Etch-It power unit (requires 230v 50Hz) - Supplied with 3 pin UK (Type G) plug
	1 x Cassette of etching paper (3m paper per cassette)
	1 x Bottle of etching fluid - 1000ml
	1 x Set of leads for attaching to equipment to be etched
	1 x Electrolyte Applicator
	1 x Etch-It printer (requires 230v 50Hz or 8 Batteries size AA (R6) - not supplied)
Consumables:	
8096A-2	Cassette of etching paper (3m paper per cassette)
8096A-3	Bottle of etching fluid - 1000ml

Please contact us for special custom made, high quality Etching Masks that can be repeatedly used.

Stainless Sample Splitter



The Sampling Systems range of sample splitters (Riffles) come in a range of sizes. The Riffles are ideal for food, environmental and chemical use.

Sample Splitters are used when dividing and reducing the bulk sample. Operation is very simple. Simply drop the sample into the top and the sample is split into two. The split sample drops into the riffle boxes underneath. Generally we recommend that the width of the slots are 2.5 to 3 times bigger than the diameter of the largest particle being split.

- Manufactured in stainless steel
- Available in different sizes from stock
- Can be used in the laboratory or on site
- Supplied with 2 receptacles

Manufactured from stainless steel. Due to the method of construction we do not recommend this for GMP pharmaceutical use.



Part No.	Number of Slots	Slot Width	Material
8601S-06	16 slots	6mm	Stainless Steel
8601S-10	16 slots	10mm	Stainless Steel
8601S-20	12 slots	20mm	Stainless Steel
8601S-30	12 slots	30mm	Stainless Steel

Riffles

The Sampling Systems range of steel Riffles are durable and efficient.

- Manufactured from painted steel
- Available in different sizes from stock
- Can be used in the laboratory or on site
- Supplied with 2 receptacles



Part No.	Number of Slots	Slot Width	Material
8600M-7	12	7mm	Painted Steel
8600M-10	12	10mm	Painted Steel
8600M-15	12	15mm	Painted Steel
8600M-20	10	20mm	Painted Steel
8600M-25	10	25mm	Painted Steel
8600M-30	10	30mm	Painted Steel
8600M-40	8	40mm	Painted Steel
8600M-50	8	50mm	Painted Steel
8600M-65	8	65mm	Painted Steel
8600M-75	8	75mm	Painted Steel
8600M-80	8	80mm	Painted Steel

Blend-It Sample Blender



The Blend-It sample blender is ideal for small scale blending work. This includes blending samples, small scale production work and research and development.

The Blend-It is not only rugged and simple to use but it will allow samples and production batches to be prepared under standard repeatable conditions.

The Blend-It is commonly used in pharmaceutical and chemical applications.

- Efficient asymmetric blending action
- Speed fixed at 28 r.p.m.
- Digital Timer
- Requires 230v 50Hz supply - (other voltages on request)
- Easily portable - weight 12kgs
- CE Mark
- Blending Containers made from 316L stainless steel



The Blend-It Sample Blender is very easy to use:

1. Fill the blending container half to two thirds with powder
2. Clamp Blending Container to the Blend-It Drive Unit
3. Set the Blend Time on the digital timer
4. Press the Start button
5. The container will blend at 28 rpm until the timer reaches zero. The blender will then automatically stop.

Note: The volume of powder being blended must not exceed two thirds of the total container volume

Part No.	Description
8750L-01	Blend-It Sample Blender Drive Unit (supplied with 3 pin UK Type G plug)
8750E-01	Blending Container - 1 litre - 316L stainless steel - silicone 'O' ring seal
8750E-02	Blending Container - 2 litres - 316L stainless steel - silicone 'O' ring seal

Cleaning Brushes

It is essential to ensure that your sampler is properly cleaned. Sampling Systems supply a range of brushes that are ideal for cleaning both stainless steel and plastic samplers.

Use the appropriate diameter and length for your sampler.

- Hygienic nylon bristles
- Robust aluminium handle
- Available in a range of lengths and diameters



Part No.	Description	Overall Length	Min. Tube Diameter	Max. Tube Diameter
8020N- 600	Narrow Brush	600mm	7mm	14mm
8020N-1100	Narrow Brush	1100mm	7mm	14mm
8020N-1600	Narrow Brush	1600mm	7mm	14mm
8020N-2100	Narrow Brush	2100mm	7mm	14mm

8020A- 600	Standard	600mm	15mm	30mm
8020A- 1100	Standard	1100mm	15mm	30mm
8020A- 1600	Standard	1600mm	15mm	30mm
8020A- 2100	Standard	2100mm	15mm	30mm

8020J-600	Wide Brush	600mm	30mm	45mm
8020J-1100	Wide Brush	1100mm	30mm	45mm
8020J-1600	Wide Brush	1600mm	30mm	45mm
8020J-2100	Wide Brush	2100mm	30mm	45mm

Quick Clip

Quick Clips provide an instant removable seal for use with layflat tubing or bags. Ideal for use in ATEX rated areas where a heat sealer can not be used.

- Seals bags fast
- Water and powder tight
- Range of sizes
- Robust
- Reusable
- Metal detectable option



Part No.	Sealing Length	Metal Detectable	Colour	Material	Quantity Per Bag
8219A-110	110mm	No	White	Polyamide	100
8219A-220	220mm	No	White	Poluamide	100
8219M-320	320mm	Yes	Blue	Acetal	10

Drum Covers

Temporary Covers for Containers

The Sampling Systems range of Drum Covers are ideal for when you need to quickly seal a drum after sampling or dispensing.

The elasticated rim means they quickly fit around drums, kegs and barrels. Drum Covers are made from antistatic LDPE that is food grade (BRC/IOP approved). The covers are ideal at minimising cross contamination and they provide an extra protective cover to the top of the drum when it is not in use.

Drum Covers can also be used to minimise dust when sampling - just cut a small hole in the cover and then take your sample. The hole can be sealed by using one of our UA labels. (see pages 189 to 195).

- Light-weight temporary cover
- Made from an antistatic grade of LDPE
- Semi opaque
- Ideal for drums, kegs, bins, totes, IBCs etc.
- Quick and easy to apply
- Available from stock



Part No.	To suit Drum Diameter	Material	Pack Size
4222A-200	200 - 420mm	LDPE	100 covers
4222A-420	420 - 650mm	LDPE	100 covers

Sack Clip

Sealing sacks after sampling or dispensing is often tricky and difficult. Our new Sack Clip is a quick, simple and effective way of closing sacks. Simply close sack between the jaws of the Sack Clip.

- Quick and easy to apply
- Quick and easy to remove
- Ratchet mechanism and secondary positive lock for double security
- Robust
- Reusable
- Metal detectable option



Part No.	Metal Detectable	Sealing Length	Colour	Material	Quantity Per Box
8010A-1	No	100mm	White	Polyamide	10
8010M-1	Yes	100mm	Blue	Acetal	10

SAMPLER CASES For safe storage and transportation



These cases are ideal for the safe storage and transportation of samplers and other equipment. They are also ideal for ensuring that your clean samplers remain clean whilst they are being stored or carried around the factory. All cases are supplied with foam inners to protect the samplers.

Accessories

Aluminium Sampler Case

The Sampling Systems range of heavy duty cases are ideal for storing samplers.

- Lockable
- Aluminium outer
- Foam lined to protect your samplers
- Strong and robust
- Supplied with a sturdy carrying handle



Part No.	Description	Internal Dimensions L x W x H
8509A-500	Aluminium Sampler Case 500mm	490 X 220 X 80mm
8509A-1200	Aluminium Sampler Case 1200mm	1200 X 220 X 80mm
8509A-1750	Aluminium Sampler Case 1750mm	1750 X 295 X 80mm

Mini Case

- Ideal for storing small samplers
- Simple clasps keep the case closed
- Economic



Part No.	Description	Internal Dimensions L x W x H
8505A-12	Mini Sampler Case	250 x 175 x 40mm

Standard Sampler Case

- Rugged plastic construction
- Four sliding clasps keep the case shut



Part No.	Description	Internal Dimensions L x W x H
8505A-01	Standard Sampler Case	1210 x 225 x 96mm

Superior Sampler Case

- Lockable (2 keys supplied)
- High impact resistant outer
- Metal hinges for a long life
- Very high quality finish



Part No.	Description	Internal Dimensions L x W x H
8500A-01	Superior Sampler Case	870 x 285 x 116mm

Jumbo Case

- Rugged plastic construction
- Extends up to 2400mm
- Excellent Value



Part No.	Description	Internal Dimensions L x W x H	Dimensions Extended
8502A-01	Jumbo Sampler Case	1800x140x140mm	2400 x140 x140mm

Special Samplers

Cost Effective Custom Design Service

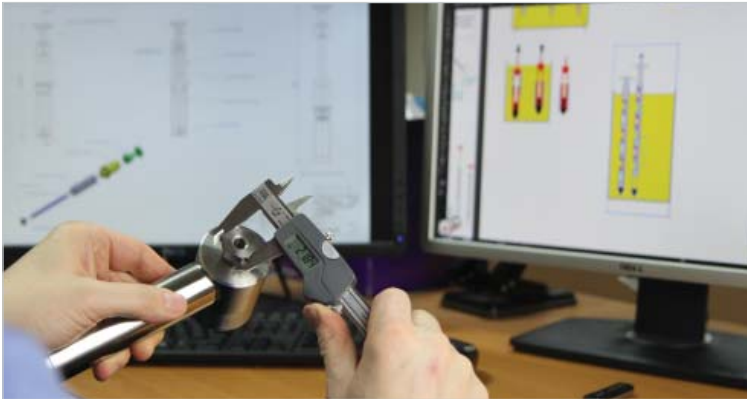

- Sampling Systems has over 25 years of designing and building custom made samplers. Whatever you require please contact us.
- Our in house designers have a huge library of past designs to work with.
- Latest 3D design software
- 3D printer to build prototypes
- *Please call to discuss your requirements*



Custom Design and Sizes

We have designed samples for virtually every type of product imaginable.

We can make custom versions of our standard samplers. They can be longer, shorter, wider, thinner etc.

Special Materials

Most of our samplers are manufactured from 316L stainless steel. We can also manufacture items from alloys such as hastelloy, titanium, PTFE etc.

Special Finishes

Whatever your finish we can help. Everything from electro-polished, pickled and passivated, mirror polish etc.

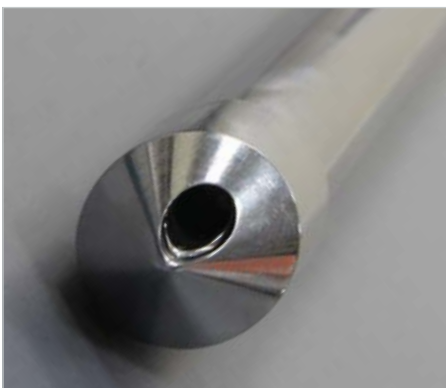



Labels





Which type of label is right for me?

Sampling Systems offer two types of standard label backing:

- Ultra Adhesive Labels
- PharmaLabels

1. Ultra Adhesive (UA) Labels

- Robust foil-backed labels
- Standard label are available in two sizes: 95mm x 95mm or 150mm x 150mm
- Very high strength adhesive - will even stick on very dusty surfaces
- Working Temperature Range -20 to +70°C (-5 to +160°F)

Dust Proof



UA Labels are ideal for sealing sacks after sampling. UA Labels will stick to virtually any surface, they will even stick to dusty sacks.

The label will not only record the fact that the sack has been sampled but it will prevent the sack from leaking powder as it is handled.

Weather Proof



Even after being submerged in water for 48 hours the UA label was intact, it was securely attached to the bag and could be written on using a ball point pen.

2. PharmaLabels (with food grade glue)

PharmaLabels are a range of paper labels with a special FDA acceptable adhesive. PharmaLabels are ideal for applications where the adhesive might come into contact with the product.

- Medium strength adhesion
- FDA acceptable adhesive (CFR175.105)
- Working Temperature Range -40 to +70°C (-40 to +160°F)



Try before you buy

Ask for your free sample pack

Quality Control Labels

Quality Control Labels are available printed on either Ultra Adhesive or PharmaLabels.

- Large writing area
- Available in two convenient sizes
- Each roll individually packed
- Available from stock for next day delivery
- Ideal for sealing dusty or split sacks (UA labels)



Part No.	Label Type	Colour	Text	Label Size	Labels per Roll
8220A-01	Ultra Adhesive	Red	Quality Control	95 x 95mm	500
8220P-01	Pharma Label	Red	Quality Control	95 x 95mm	500
8220A-001	Ultra Adhesive	Red	Quality Control	150 x 150mm	250
8220P-001	Pharma Label	Red	Quality Control	150 x 150mm	250

Ultra Adhesive = very strong glue

Pharma Labels = food grade, medium strength glue



Part No.	Label Type	Colour	Text	Label Size	Labels per Roll
8220A-02	Ultra Adhesive	Green	Quality Control	95 x 95mm	500
8220P-02	Pharma Label	Green	Quality Control	95 x 95mm	500
8220A-002	Ultra Adhesive	Green	Quality Control	150 x 150mm	250
8220P-002	Pharma Label	Green	Quality Control	150 x 150mm	250

Ultra Adhesive = very strong glue

Pharma Labels = food grade, medium strength glue



Part No.	Label Type	Colour	Text	Label Size	Labels per Roll
8220A-03	Ultra Adhesive	Yellow	Quality Control	95 x 95mm	500
8220P-03	Pharma Label	Yellow	Quality Control	95 x 95mm	500
8220A-003	Ultra Adhesive	Yellow	Quality Control	150 x 150mm	250
8220P-003	Pharma Label	Yellow	Quality Control	150 x 150mm	250

Ultra Adhesive = very strong glue

Pharma Labels = food grade, medium strength glue



Part No.	Label Type	Colour	Text	Label Size	Labels per Roll
8220A-04	Ultra Adhesive	Blue	Quality Control	95 x 95mm	500
8220P-04	Pharma Label	Blue	Quality Control	95 x 95mm	500
8220A-004	Ultra Adhesive	Blue	Quality Control	150 x 150mm	250
8220P-004	Pharma Label	Blue	Quality Control	150 x 150mm	250

Ultra Adhesive = very strong glue

Pharma Labels = food grade, medium strength glue



Part No.	Label Type	Colour	Text	Label Size	Labels per Roll
8220A-05	Ultra Adhesive	Black	Quality Control	95 x 95mm	500
8220P-05	Pharma Label	Black	Quality Control	95 x 95mm	500
8220A-005	Ultra Adhesive	Black	Quality Control	150 x 150mm	250
8220P-005	Pharma Label	Black	Quality Control	150 x 150mm	250

Ultra Adhesive = very strong glue

Pharma Labels = food grade, medium strength glue



Part No.	Label Type	Colour	Text	Label Size	Labels per Roll
8220A-06	Ultra Adhesive	White	n/a	95 x 95mm	500
8220P-06	Pharma Label	White	n/a	95 x 95mm	500
8220A-006	Ultra Adhesive	White	n/a	150 x 150mm	250
8220P-006	Pharma Label	White	n/a	150 x 150mm	250

Ultra Adhesive = very strong glue

Pharma Labels = food grade, medium strength glue

Process Labels



Process Labels are designed to help prevent errors during the manufacturing process.

- Colour coded for improved recognition by operators
- Printed on Ultra Adhesive labels
- Each roll individually wrapped
- Available from stock for next day delivery
- Ideal for sealing dusty sacks (UA labels)



Part No.	Label Type	Colour	Text	Label Size	Labels per Roll
8220A-30	Ultra Adhesive	Green	Released	95 x 95mm	500

Ultra Adhesive = very strong glue

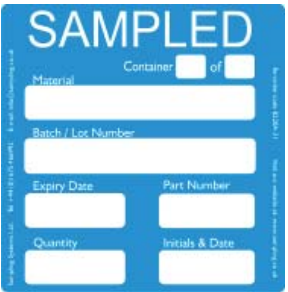

Part No.	Label Type	Colour	Text	Label Size	Labels per Roll
8220A-31	Ultra Adhesive	Blue	Sampled	95 x 95mm	500
8220P-31	Pharma Label	Blue	Sampled	95 x 95mm	500
8220P-031	Pharma Label	Blue	Sampled	150 x 150mm	250

Ultra Adhesive = very strong glue

Pharma Labels = food grade, medium strength glue



Part No.	Label Type	Colour	Text	Label Size	Labels per Roll
8220A-32	Ultra Adhesive	Orange	Quarantine	95 x 95mm	500

Ultra Adhesive = very strong glue



Part No.	Label Type	Colour	Text	Label Size	Labels per Roll
8220A-33	Ultra Adhesive	Black	Rejected	95 x 95mm	500

Ultra Adhesive = very strong glue

Labels

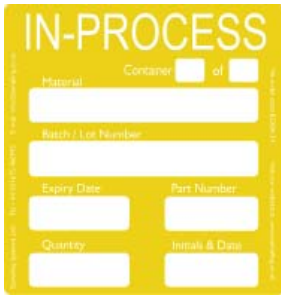

Part No.	Label Type	Colour	Text	Label Size	Labels per Roll
8220A-34	Ultra Adhesive	Yellow	In-Process	95 x 95mm	500

Ultra Adhesive = very strong glue



Part No.	Label Type	Colour	Text	Label Size	Labels per Roll
8220A-35	Ultra Adhesive	Red	Dispensed	95 x 95mm	500

Ultra Adhesive = very strong glue



Part No.	Label Type	Colour	Text	Label Size	Labels per Roll
8220A-51	Ultra Adhesive	Red / Yellow	Allergen	95 x 95mm	500

Ultra Adhesive = very strong glue



Part No.	Label Type	Colour	Text	Label Size	Labels per Roll
8220A-52	Ultra Adhesive	Red	Dirty	95 x 95mm	500

Ultra Adhesive = very strong glue



Part No.	Label Type	Colour	Text	Label Size	Labels per Roll
8220A-53	Ultra Adhesive	Green	Clean	95 x 95mm	500

Ultra Adhesive = very strong glue



Part No.	Label Type	Colour	Text	Label Size	Labels per Roll
8220A-54	Ultra Adhesive	Blue	Not For Human Use	95 x 95mm	500

Ultra Adhesive = very strong glue

Clear Labels

A see-through label with a food grade adhesive



Clear Labels are ideal for sealing bags and sacks. These labels are made from a clear polypropylene film and they have an FDA acceptable adhesive. Clear Labels are ideal for sealing sampling holes. The label is transparent so that printing underneath the label can still be easily read.

Clear Labels are suitable for some types of NIR. Contact us for a free sample to test.



- Each roll is individually wrapped
- 95mm x 95mm size
- Adhesive conforms to FDA CFR175.105



Part No.	Label Type	Colour	Size	Number of Labels per Roll
8220C-01	Pharma Labels	Clear	95 x 95mm	500

Pharma Labels = food grade, medium strength glue

Custom Labels



Simply sketch your design on paper and email it to Sampling Systems and we will do the rest.

- Custom labels to your design specification
- Available as PharmaLabels or UA Labels
- Any size or shape of label is possible
- Single colour or full colour printing is available
- Minimum order 5 rolls
- Typical delivery time is 2 weeks
- Contact Sampling Systems for further information

UA Tape

Ultra Adhesive Tape for sealing sacks



UA (ultra adhesive) Tape is ideal for sealing holes in sacks and bags. The tape comes in a roll that is 50m long so you just cut off as much as you need.

- Tape uses the same glue as Ultra Adhesive labels
- Available in 2 widths - 95mm and 50mm
- Available from stock



Part No.	Adhesive	Colour	Tape Length	Tape Width
8224A-50	Ultra Adhesive (UA)	White	50m (approx.)	50mm
8224A-95	Ultra Adhesive (UA)	White	50m (approx.)	95mm

Label Dispensers

Label Dispensers are useful for storing labels and they provide a flat writing area. Label Dispensers are made from sturdy aluminium and are available in two sizes.



Part No.	Label Type
8220A-07	Label Dispensers for 95mm wide labels
8220A-17	Label Dispensers for 150mm wide labels



ID Tape

Helps prevent handling errors

Sampling Systems ID Tape is available in a range of styles. Containers, bags etc. can be easily labelled with highly visible tape. Quickly identify the status of a container to prevent it being used in error.

- Use with standard tape dispensers
- High strength adhesive
- 10 rolls per box



Part No.	Text	Text Colour	Length per Roll	Width	Rolls per Box
8221A-01	Quarantine	Red	66m	50mm	10
8221A-02	Sampled	Red	66m	50mm	10
8221A-03	Released	Red	66m	50mm	10
8221A-04	Rejected	Red	66m	50mm	10

Material Identification Service

Positive Material Identification using X-Ray Fluorescence

X-Ray Fluorescence (XRF) is an FDA approved material identification technique.

Our XRF analyser can quickly identify different grades of stainless steel as well as hundreds of other alloys.

XRF is a non-marking, non-destructive technique and so can be used to test finished products.

What's wrong with Mill Certificates?

We have never been happy with supplying Mill Certificates because:

- They were frequently difficult to read (due to being faxed and copied many times)
- They were reliant on everybody in the supply chain being meticulous in their record keeping
- It was too easy for mistakes to be made

XRF Reports

We will issue a certificate identifying the alloy used for each part of your equipment. Please note that XRF is only suitable for testing metallic components.



Important Note
We are only able to offer XRF testing on our own products and for insurance reasons this testing may only be carried out at our premises.

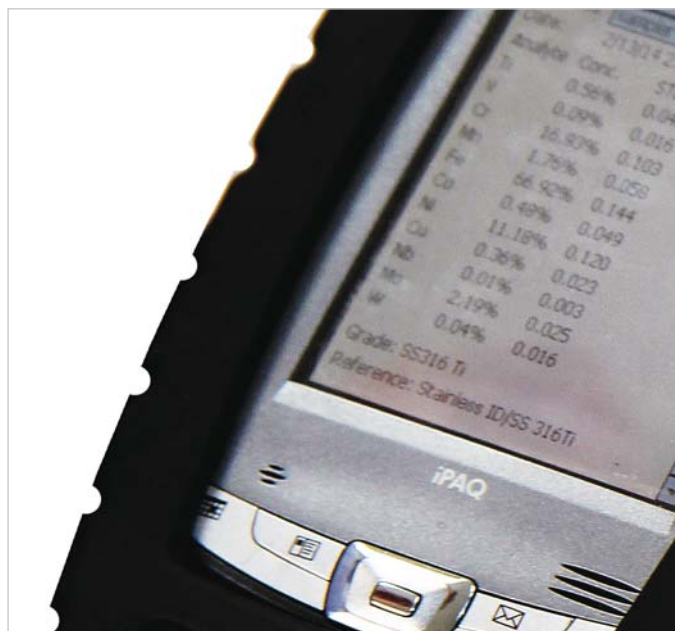

Part No.	Description
XRF-PMI	XRF testing per sampler

Key



Sterile



Material: PP



304 stainless steel



Next day delivery



Cleanroom Produced



Material: HDPE



316L stainless steel



Download certificates



Material: PE



Food Grade



Video

Chemical Resistance Chart

	Polyethylene (LDPE & HDPE)	Polypropylene (PP)	Polyvinyl Chloride (PVC)	PTFE	Polystyrene (PS)	Silicone Rubber	Viton®	EPDM	Nitrile	316 Stainless Steel (V4A)	304 Stainless Steel (V2A)	Hastelloy C22	Aluminium
Acetaldehyde	3	1	4	1	4	2	4	2	4	1	1	1	2
Acetic Acid (Glacial)	4	1	4	1	4	2	4	2	3	1	3	1	2
Acetic Acid (Dilute)	1	2	4	1	1	1	2	1	3	1	3	1	2
Acetone (Dimethyl Ketone)	4	1	4	1	4	4	4	1	4	1	1	1	1
Aluminium Chloride	2	1	1	1	1	2	1	1	1	2	2	1	4
Ammonia (Liquid)	3	1	1	1	2	?	4	?	3	1	2	2	1
Amyl Acetate	3	2	4	1	4	4	4	1	4	1	1	1	1
Benzene	3	4	3	1	4	4	1	4	4	2	2	2	2
Calcium Hypochlorite	1	1	2	1	1	2	1	1	3	2	3	2	4
Carbon Tetrachloride	4	4	4	1	4	4	1	4	4	2	2	1	4
Chloroform (Trichloromethane)	3	3	4	1	4	4	1	4	4	1	1	1	2
Citric Acid	4	1	2	1	1	1	1	1	1	1	2	1	3
Cod Liver Oil	?	1	1	1	2	2	1	1	1	1	1	1	1
Cupric Acid	2	1	1	1	?	1	1	?	2	2	4	1	4
Cyclohexane	2	4	4	1	2	4	1	4	2	1	1	2	1
Cyclohexanone	4	4	4	1	4	4	4	2	4	1	1	1	1
Diesel	3	1	1	1	2	4	1	4	1	1	1	2	1
Diethylamine	4	1	4	4	?	2	1	3	3	1	1	1	2
Epsom Salts (Magnesium Sulfate)	1	1	1	1	?	1	1	1	1	2	1	2	2
Ethanol (Ethyl alcohol)	1	1	3	1	1	2	1	1	3	1	1	1	2
Ethanolamine	?	4	4	1	?	2	4	2	2	1	1	2	2
Ether (Ethyl Ether)	4	4	4	1	4	4	3	3	4	1	1	2	2
Ethylene Glycol	4	1	1	1	1	4	1	1	1	2	2	1	2
Ethylene Oxide	1	4	4	1	4	4	4	3	4	2	2	1	4
Ferrous Sulfate	1	1	1	1	1	1	1	1	1	2	2	2	2
Formic Acid (Methanoic Acid)	4	1	1	1	2	2	3	2	3	1	2	1	1
Gasoline	3	1	1	2	4	4	1	4	1	1	1	1	4
Hexane	4	2	2	1	4	4	1	4	1	1	1	1	1
Hydrochloric Acid (20%)	1	2	1	1	1	4	1	1	?	4	4	1	4
Hydrochloric Acid (Conc.)	?	2	4	1	2	4	1	1	4	4	4	1	4
Hydrofluoric Acid (20%)	1	1	2	1	4	4	1	1	4	4	4	2	4
Hydrogen Peroxide (10%)	1	1	1	1	1	1	1	1	4	2	2	1	1
Hydrogen Peroxide (90%)	3	2	1	1	2	2	1	1	4	1	2	1	1
Isopropanol (Isopropyl Alcohol)	1	1	1	1	1	1	1	1	?	1	1	?	?
Kerosene	3	2	1	1	2	4	1	4	1	1	1	2	1
Magnesium Chloride	1	1	2	1	?	1	1	1	1	4	4	2	4
Methanol (Methyl alcohol)	1	1	1	1	2	2	1	1	1	1	1	1	1
Methyl Ethyl Ketone	2	2	4	1	4	4	4	1	4	1	1	1	2
Milk	1	2	1	1	1	1	1	1	1	1	1	1	1
Naphtha	1	2	1	2	3	?	4	4	2	1	1	1	2
Nitric Acid (10%)	2	1	1	1	2	3	1	2	4	1	1	1	1
Nitric Acid (Conc.)	3	4	2	1	4	4	1	4	4	1	1	2	4
Nitrobenzene	3	2	4	1	?	4	2	4	4	2	2	4	2
Paraffin	2	1	2	1	2	?	2	1	2	1	1	2	1
Phenol (Carbolic Acid)	4	2	4	1	4	4	1	2	4	2	2	1	1
Phosphoric Acid (Conc)	2	1	2	1	1	4	1	2	4	4	3	1	3
Picric Acid	1	2	4	1	?	4	1	1	3	2	2	2	3
Potassium Chloride	1	1	1	1	1	1	1	1	1	1	2	1	4
Potassium Dichromate	1	1	1	1	?	1	1	1	1	2	2	2	2
Pyridine	2	1	4	1	4	4	4	2	4	1	1	2	2
Sodium Carbonate	2	1	1	1	1	1	1	1	1	1	1	1	4
Sodium Fluoride	1	1	1	1	2	?	1	1	1	4	4	1	2
Sodium Hydroxide (Caustic Soda)	4	1	1	1	2	1	2	1	4	2	3	1	4
Sodium Hypochlorite 20%	1	1	1	1	2	2	1	2	2	3	3	1	4
Starch	2	1	1	1	1	1	1	1	1	1	1	1	1
Sulfuric Acid (10%)	1	1	1	1	1	4	1	2	2	3	4	2	4
Sulfuric Acid (Hot Conc.)	4	4	4	1	4	4	1	4	4	3	4	4	4
Tetrachloroethane	?	3	3	1	?	4	1	4	4	1	2	1	3
Tetrahydrofuran (THF)	3	3	4	1	4	4	4	3	4	1	1	1	?
Toluene (Methylbenzene)	3	3	4	1	4	4	3	4	4	1	1	1	1
Xylene (Dimethylbenzene)	2	2	4	1	4	4	4	4	4	2	2	1	1

Key

1 = Excellent 2 = Good 3 = Fair 4 = Poor, not recommended for prolonged contact ? = No data

Important Notice: Sampling Systems do not accept any responsibility for any errors in this table. It is the responsibility of the end user to carry out their own compatibility tests.

Index by Name

Description	Page
AccuPod	74-75
Bags	138
Bailer	161
Beakers	142
Blend-It	183
Bottle Sampler	96
Bottles	22-23, 135-152
Bowls	24, 166
Brushes	184
Buckets	167
Capsule Counting Tray	14
Carboy	136
Cases	186-187
Cement Sampler	66
Cereal Trier	130
Clamp Containers	146
Cleaning Coupons	176
Cohesive Pocket Sampler	84
Cohesive Sampler	83
Cohesive Slot Sampler	85
Corer	116
Cup Sampler	97
Custom Labels	194
Deep Water Sampler	99, 131
Dippers	104-105
Disposable Bailer	114, 132
Disposable Products	7-52
Drum Cover	185
Earthing Lugs	166
EnviroDipper	102, 128
Etch-It	181
Flat Spatula	20
Fluid Point Sampler	98
Forceps	29, 175
FreeGlide	86-87
Funnels	164-165
Disposable Funnels	28-29
GL45 Containers	147
Grab It	177
Grain Spear	129
Hand Reel & Cables	106, 126
Ice Borer	120
Ice Cream Sampler	122
Ice Sampler	119
ID Tape	195
In Line Sample Valve	112-113
In-Stream Sampler	99, 131, 161
Jugs	25, 170-171
Jumbo Pipette	50
Knife	27
Label Dispensers	195
Labels	190-195
Ladles	48, 160
Liquid Master	90-91
LiquiDip	46-47
LiquiThief	49
Long Handled Scoop	9
Long Handled Spoon	15
Maxi Corer	81, 116
Measuring Scoop	66
Micro Spatulas	21
MicroMate	65
MicroThief	64
Mini Corer	116
Mini-Drums	148
Mini-Pots	141
Mono Pocket Sampler	56
Mono Slot Sampler	38
Multi Dipper 2	101
MultiThief	69
Paddles	174
Pallet Knife	26, 162-163
Pasteur Pipette	108
Pharma Bottle	144

Description	Page
Pocket Sampler	72-73
Point Sampler	58
Pots with Lids	142
Powder Lance	41, 82
Powder Bottle	22
Powder Max	62
Powder Pots	142
Powder Probe	40
Powder Sampler	45
Powder Safe	44
Powder Spatula	34-37
Powder Thief	42-43, 54-55
Powder Trier	77
Powered Ice Sampler	122
PP Tubs	135
PTFE Dipper	105-106
PTFE Pot	137
Pump Sampler	92-93
Pumps	110-111
Quick Clip	184
Road Tanker Sampler	114
Riffler	182
Sack Clip	185
Sack Master	60-61
Sack Sampler	30, 60-61
Sample Lance	88, 121
Sample Splitter	182
Sampler Rack	177
Sampling Kit	23, 132
Scissors	175
Scoops - plastic disposable	10-13
Scoops - stainless steel	154-159
Scraper	26, 162-163
Seal-It	180
Shovel	174
Sieve-It Test Sieves	179
Sieving Tool	166
Silo Rocket	59
Sleeve Sampler	57
Slot Sampler	39, 70-71
Snapper	98, 130
Soil Samplers	128, 133
Spades	see Scoops
Spatulas	168-169
Spoons	16-18, 168-169
Stainless Containers	141-152
Stainless Storage Drums	151
SteriWare Products	7-51
Stirrer	20, 174
Storage Containers	150
Sub Sampler	106, 126
Sub Sampler Pro	107, 127
Tablet Counting Triangle	14, 172
TeleScoop	94-95, 124-125
Telescopic Sampler	63
TeleSwab	178
Thermometer	176
Thumb Tube Pipettes	52
Tips	56
Toggle Drums	149
Trays	27, 172-173
Titrating Burette	177
Tweezers	29, 175
UD Cohesive Sampler	68
UD Doser	103
UD Master	78-79
UD Sleeve Sampler	67
UD Tablet Maker	80
Unit Dose Sample Thief	76
Utility Dipper	100
V Spatula	31-33, 81
ViscoThief	51
Viscous Sampler	118
Volumetric Spoon	19, 169
XRF testing service	196

Index by Part Number

Part No.	Page
1030	54-55
1035	57
1070	65
1074	64
1095	81
1120	66
1210	70-71
1213	62
1216	77
1220	72-73
1230	78-80
1290	69
1309	61
1320	60
1360	74-75
1430	56
1500	67
1620	128
1640	58
1660	88, 121
1665	88, 121
1900	66
1942	129
1985	59
2000	68
2015	83
2210	85
2220	84
2250	82
2750	133
4222	185
4710	133
5005	104, 160
5010	103
5020	92-93
5030	97
5031	96
5035	90-91
5040	114, 132
5045	101
5054	52
5055	52
5056	110
5058	110
5061	98
5065	63, 94-95, 124-125
5065F	104
5070	106, 128
5072	107, 127
5073	106, 126
5079	99, 131
5100	104, 105
5170	100
5174	112-113
5551	98
5740	114
5900	111
6000	119
6005	120
6006	122
6010	122
6060	180
7000	118
7008	116
7009	116
7010	81, 116
8005	73
8010	185
8011	178
8015	21
8017	24
8020	184
8022	165
8023	164

Part No.	Page
8025	29
8039	27
8045	10-13
8049	25
8050	49
8051	50
8053	48
8055	51
8060	42-43
8063	41
8064	40
8066	14
8069	38
8073	39
8079	138
8080	138
8081	27
8085	30, 61
8088	16-17
8095	34-35
8096	181
8097	44
8110	137
8111	29
8115	31-33
8121	135
8126	135-136
8130	93
8131	136
8132	136
8134	108
8165	60
8175	26
8180	135
8200	111
8209	15
8219	184
8220	191-195
8221	195
8228	174
8235	137
8240	45
8246	140
8284	36-37
8293	15
8331	174
8332	174
8333	174
8341	9
8370	28
8404	23
8420	177
8432	25
8440	31-33
8444	14
8480	23, 132
8500	187
8502	187
8505	187
8509	186
8570	120
8600	182
8601	182
8640	19
8642	18
8644	176
8700	179
8702	176
8703	177
8729	20
8750	183
8785	26
8820	177
8890	22, 139
8920	46-47

Part No.	Page
8921	46-47
A100	169
A105	165
A106	169
A115	137
A125	137
A126	151
A136	152
A154	171
A166	142
A186	171
A196	152
A200	163
A201	163
A204	171
A206	171
A224	173
A234	173
A244	165
A264	167
A284	142
A296	161
A304	159
A314	159
A316	155
A324	105, 160
A326	105, 160
A330	163
A333	159
A334	159
A335	169
A336	157
A344	174
A346	156
A350	163
A356	172
A364	175
A366	156
A376	156
A384	152
A394	175
A396	156
A416	145
A417	147
A418	147
A426	141
A434	148
A446	148
A454	150
A466	150
A504	169
A506	58, 169
A516	166
A534	166
A555	175
A566	146
A586	167
A624	148
A626	148
A643	159
A656	163
A674	172
A684	172
A686	167
A694	150
A696	150
A716	164
A725	102, 128
A736	142
A764	161
A776	154
A836	143
A846	144
A904	166
A916	174
A926	149
A996	99, 131, 161



**SAMPLING
SYSTEMS**

www.sampling.com

Wherever you are we are local



ADDRESS:

Sampling Systems Ltd.
4 & 5 Forge Mills Park,
Coleshill,
Warwickshire.
B46 1JH
UK

TELEPHONE:

01675 466992 (from UK)
1-888-414-6448 (Toll Free from USA)
+44 (0)1675 466992 (International)

EMAIL:

info@sampling.com

WEB:

www.sampling.com

QMS

ISO 9001
REGISTERED

Sampling Systems Ltd. © 2018

'SteriWare', 'PharmaScoop', 'AccuPod', 'PharmaBottle' and 'FreeGlide' are Trade Marks of Sampling Systems Ltd.

1. All goods are sold subject to our normal Terms and Conditions, contact us for a copy.
2. Sampling Systems operates a process of continual improvement and so we reserve the right to vary specifications at any time.
3. Whilst every effort has been made to ensure the accuracy of the information given in this catalogue, Sampling Systems will not accept any responsibility for any inaccuracies.